

C-Series

CIRCUIT BREAKER

The C-Series hydraulic-magnetic circuit breakers are ideal for applications that require higher amperage and voltage handling capability in a smaller package. They are available in 1-6 poles, 0.02-100amps, UL Recognized up to 480VAC or 150VDC, UL489 Listed up to 240VAC or 125VDC, with choice of time delays, terminal options, actuator styles and colors. The C-Series employs a unique arc chute design which allows for higher interrupting capacities of up to 10,000 amps. Thermoset glass filled polyester half shell construction provides for increased mechanical and electrical strength. The wiping contacts mechanical linkage, with two step actuation, cleans contacts providing high, positive contact pressure and longer contact life. Available with American Standard or Metric Threaded Stud terminals, or Saddle Clamp screw terminals. The optional mid-trip handle style actuator allows a visual indication of electrical overload with or without alarm feature.



Product Highlights:

- Extensive list of Agency Approvals
- Available with Standard or Metric Stud terminals, or Saddle Clamp screw terminals
- Optional mid-trip handle style actuator
- Unique arc chute design which allows for higher interrupting capacities of up to 10,000 amps
- Exclusive Rockerguard and Push-To-Reset bezel
- Available with new solid color and two-color Visi-rocker® actuators
- New thermoset glass filled polyester half shell construction

Typical Applications:

- Marine
- Telecom/Datacom
- Military
- Renewable Energy
- Generators & Welders



Electrical

| | |
|-------------------------|---|
| Maximum Voltage | AC, 480 WYE/277 VAC, 50/60 Hz (see Table A.) UL489: AC,240 VAC. (See Table D), 50/60 Hz, 125 VDC |
| Current Rating | Standard current coils: 0.100, 0.250, 0.500, 0.750, 1.00, 2.50, 5.00, 7.50, 10.0, 15.0, 25.0, 30.0, 35.0, 40.0, 50.0, 60.0, 70.0, 80.0, 90.0 and 100 amps. Other ratings available, see Ordering Scheme. |
| Standard Voltage Coils | DC - 6V, 12V; AC - 120V; other ratings available, see Ordering Scheme. |
| Auxiliary Switch Rating | SPDT; 10.1 amps-250VAC, DC Aux. Switch 1.0A, 65 VDC. 0.5A, 80VDC, 1/4 HP, 125VAC, VDE & TUV 1.0 125 VAC. |
| Insulation Resistance | Minimum of 100 Megohms at 500 VDC. |
| Dielectric Strength | UL, CSA: 1960 V 50/60 Hz for one minute between all electrically isolated terminals. C-Series Circuit Breakers comply with the 8mm spacing and 3750V 50/60 Hz dielectric requirements from hazardous voltage to operator accessible surfaces, between adjacent poles and from main circuits to auxiliary circuits per Publications EN 60950 and VDE 0805. |
| Resistance, Impedance | Values from Line to Load Terminal - based on Series Trip Circuit Breaker. |

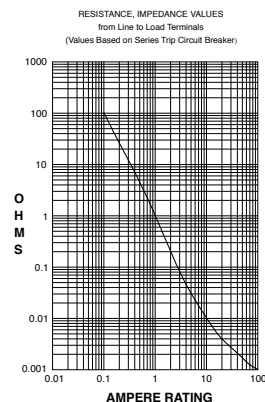

| CURRENT (AMPS) | TOLERANCE (%) |
|----------------|---------------|
| 0.10 - 5.0 | 15 |
| 5.1 - 20.0 | 25 |
| 20.1 - 50.0 | 35 |

Pulse Tolerance Curves

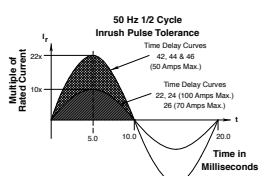
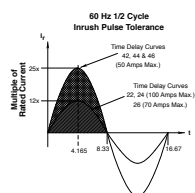

*Manufacturer reserves the right to change product specification without prior notice.

Mechanical

| | |
|-----------------|--|
| Endurance | 10,000 ON-OFF operations @ 6 per minute; with rated current & voltage. |
| Trip Free | All C-Series circuit breakers will trip on overload, even when actuator is forcibly held in the ON position. |
| Trip Indication | The operating actuator moves positively to the OFF position when an overload causes the breaker to trip. With mid-trip, handle moves to the mid position on electrical trip of the circuit breaker. With mid trip handle with alarm switch, handle moves to the mid position and the alarm switch actuates when the circuit breaker is electrically tripped. |

Physical

| | |
|--------------------------|--|
| Number of Poles | 1-6 poles ≤ 50A; 1-4 poles @ 51-70A; 1-2 poles 71-100A. UL489 Handle: 1 pole ≤ 100A, 2 pole ≤ 50A; Rocker: 1 pole ≤ 100A. |
| Internal Circuit Config. | Series (with or without auxiliary switch, mid trip & mid trip with alarm switch) Shunt & Relay with current or voltage trip coils, Dual Coil, Switch Only (with or without aux. switch). UL489: Series (with or without auxiliary switch, mid-trip & midtrip with alarm switch). |
| Weight | Approx. 112 grams/pole (3.95 oz). |
| Standard Colors | Housing: Black |

Environmental

| | |
|--|--|
| Designed and tested in accordance with requirements of specification MIL-PRF-55629 & MIL-STD-202 as follows: | |
| Shock | Withstands 100 Gs, 6ms sawtooth while carrying rated current per Method 213, Test Condition "I". Instantaneous and ultrashort curves tested @ 90% of rated current. |
| Vibration | Withstands 0.060" excursion from 10-55 Hz & 10 Gs 55-500 Hz, @ rated current per Method 204C, Test Cond. A. Instantaneous & ultrashort curves tested @ 90% of rated current. |
| Moisture Resistance | Method 106D, i.e., ten 24-hour cycles @ +25°C to +65°C, 80-98% RH. |
| Salt Spray | Method 101, Condition A (90-95% RH @ 5% NaCl Solution, 96 hrs). |
| Thermal Shock | Method 107D, Condition A (five cycles @ -55°C to +25°C to +85°C to +25°C). |
| Operating Temperature | -40°C to +85°C |

Electrical Tables

Table A: Lists UL Recognized & CSA Accepted configurations and performance capabilities as a component supplementary protector

| C-SERIES TABLE A: Component Supplementary Protectors | | | | | | | | | | | | |
|--|-------------|-----------|-----------|----------------|----------------------|-------------------------------|----------------------|-------------------|-----------------|---|------------------------------------|--|
| Circuit Configuration | Voltage | | | Current Rating | | Short Circuit Capacity (Amps) | | Application Codes | | Construction Notes | | |
| | Max. Rating | Frequency | Phase | Full Load Amps | General Purpose Amps | UL / CSA | | UL | CSA | | | |
| | | | | | | With Backup Fuse | Without Backup Fuse | | | | | |
| Series | 32 | DC | --- | 0.02 - 100 | --- | --- | 5,000 | TC1, OL1, U2 | TC1, OL1, U2 | --- | | |
| | 48 | DC | --- | 110 - 150 | --- | --- | 5,000 | | | --- | | |
| | 65 | DC | --- | 0.02 - 70 | --- | 71 - 100 | --- | 5,000 | TC1, 2, OL1, U1 | TC1, 2, OL1, U1 | --- | |
| | | | | - | --- | | | | TC1, 2, OL0, U1 | TC1, 2, OL0, U1 | --- | |
| | 80 | DC | --- | 0.02 - 70 | --- | 71 - 100 | --- | 7,500 | TC1, 2, OL1, U1 | TC1, 2, OL1, U1 | --- | |
| | | | | --- | --- | | | | TC1, 2, OL0, U1 | TC1, 2, OL0, U1 | --- | |
| | | | | 0.02 - 70 | --- | | | | --- | 10,000 | TC1, 2, OL1, U1 | TC1, 2, OL1, U1 |
| | --- | --- | 71 - 100 | --- | --- | --- | TC1, 2, OL0, U1 | TC1, 2, OL0, U1 | | | | |
| | 125 | DC | --- | 0.02 - 50 | --- | --- | 5,000 | TC1, 2, OL1, U1 | TC1, 2, OL1, U1 | Must have Agency "L" | | |
| | 125/250 | DC | --- | 0.02 - 50 | --- | --- | 5,000 | TC1, 2, OL1, U1 | TC1, 2, OL1, U1 | Must have Agency "L" | | |
| | 250 | DC | --- | 0.02 - 50 | --- | --- | 5,000 | TC1, 2, OL1, U1 | TC1, 2, OL1, U1 | Must have Agency "L": 250 volts requires 2 pole | | |
| | 125 | 50 / 60 | 1 | 0.02 - 100 | --- | --- | --- | 3,000 | TC1, OL1, U2 | TC1, OL1, U2 | Per pole rating | |
| | | | | | | | | 5,000 | TC1, 2, OL1, U1 | TC1, 2, OL1, U1 | Must have Agency "L" | |
| | 150 | DC | --- | --- | --- | 80 - 100 | --- | 5,000 | TC1, 2, OL0, U3 | --- | Must have Agency "L" | |
| | | | | | | | | | | | 101 - 175 | --- |
| | 125/250 | 50 / 60 | 1 | 0.02 - 100 | --- | --- | --- | 3,500 | TC1, OL1, U2 | TC1, OL1, U2 | --- | |
| | | | | 0.02 - 50 | | | | --- | 3,000 | TC1, 2, OL1, U1 | TC1, 2, OL1, U1 | 2 or 3 poles breaking single phase |
| | | | | 51 - 100 | | | | --- | 1,000 | TC1, 2, OL1, U1 | TC1, 2, OL1, U1 | 2 or 3 poles breaking single phase |
| | | | | 0.02 - 100 | | | | --- | 5,000 | TC1, 2, OL1, U2 | TC1, 2, OL1, U2 | 2 or 3 poles breaking single phase. Agency "L" |
| | 250 | 50 / 60 | 1 | 0.02 - 50 | --- | --- | --- | 3,500 | TC1, 2, OL1, U2 | TC1, 2, OL1, U2 | Per pole rating | |
| | | | | 0.02 - 100 | | | | --- | 5,000 | TC1, 2, OL1, U1 | TC1, 2, OL1, U1 | Must have Agency "L" |
| | | | | 51 - 70 | | | | --- | 5,000 | --- | --- | --- |
| | | | 3 | --- | 0.02 - 100 | --- | 3,000 | TC1, 2, OL0, U2 | TC1, 2, OL0, U2 | --- | | |
| | | | | --- | 0.02 - 70 | --- | 5,000 | --- | --- | 3 poles breaking 3 phase | | |
| --- | --- | 0.02 - 90 | --- | 5,000 | TC1, 2, OL0, U1 | TC1, 2, OL0, U1 | Must have Agency "L" | | | | | |
| 277 | 50 / 60 | 1 | 0.02 - 50 | --- | --- | 5,000 | --- | --- | --- | | | |
| 480/277 | 50 / 60 | 3 | 0.02 - 30 | --- | --- | --- | 5,000 | --- | --- | 3 poles breaking 3 phase | | |
| | | | | | | | --- | --- | --- | --- | --- | |
| 480 | 50 / 60 | 1 | 0.02 - 30 | --- | --- | --- | 5,000 | --- | --- | 2 poles breaking 1 phase | | |
| | | | | | | | --- | --- | --- | --- | --- | |
| Dual Coil | 80 | DC | --- | 0.02 - 50 | --- | --- | 7,500 | TC1, 2, OL1, U1 | TC1, 2, OL1, U1 | --- | | |
| | 125 | 50 / 60 | 1 | 0.02 - 50 | --- | --- | 3,000 | TC1, OL1, U2 | TC1, OL1, U2 | Per pole rating | | |
| | 125/250 | 50 / 60 | 1 | 0.02 - 50 | --- | --- | --- | 3,500 | TC1, OL1, U2 | TC1, OL1, U2 | 2 or 3 poles breaking single phase | |
| | | | | | | | | 3,000 | TC1, 2, OL1, U1 | TC1, 2, OL1, U1 | 2 or 3 poles breaking single phase | |
| | 250 | 50 / 60 | 1 | 0.02 - 50 | --- | --- | --- | 3,500 | TC1, OL1, U2 | TC1, OL1, U2 | --- | |
| | | | 3 | | | | | --- | 3,000 | TC1, OL0, U2 | TC1, OL0, U2 | Per pole rating |
| | --- | --- | --- | --- | --- | --- | --- | 5,000 | --- | --- | --- | |
| 277 | 50 / 60 | 1 | 0.02 - 50 | --- | --- | --- | 5,000 | --- | --- | 3 poles breaking 3 phase | | |
| Shunt | 80 | DC | --- | 0.02 - 50 | --- | --- | 7,500 | TC1, 2, OL1, U1 | TC1, 2, OL1, U1 | --- | | |
| | 277 | 50 / 60 | 1 | 0.02 - 50 | --- | --- | 5,000 | --- | --- | --- | | |
| | 250 | 50 / 60 | 3 | 0.02 - 50 | --- | --- | --- | 5,000 | --- | --- | 3 poles breaking 3 phase | |
| | | | | | | | | --- | --- | --- | --- | --- |
| | 480/277 | 50 / 60 | 3 | 0.02 - 30 | --- | 31 - 50 | --- | 5,000 | --- | --- | 3 poles breaking 3 phase | |
| | | | | --- | --- | | | --- | --- | --- | | |
| 480 | 50 / 60 | 1 | 0.02 - 30 | --- | 31 - 50 | --- | 5,000 | --- | --- | 2 poles breaking 1 phase | | |
| | | | --- | --- | | | --- | --- | --- | | | |
| Relay | 80 | DC | --- | 0.02 - 50 | --- | --- | 7,500 | TC1, 2, OL1, U1 | TC1, 2, OL1, U1 | --- | | |
| | 277 | 50 / 60 | 1 | 0.02 - 50 | --- | --- | 5,000 | --- | --- | --- | | |
| | 250 | 50 / 60 | 3 | 0.02 - 50 | --- | --- | 5,000 | --- | --- | 3 poles breaking 3 phase | | |
| Switch Only | 65 | DC | --- | 71 - 100 | --- | --- | --- | --- | --- | --- | | |
| | | | | --- | --- | --- | --- | --- | | | | |
| | 80 | DC | --- | 71 - 100 | --- | --- | --- | --- | --- | | | |
| | 125 | 50 / 60 | 1 | 0.02 - 100 | --- | --- | --- | --- | --- | | | |
| | 125/250 | 50 / 60 | 1 | 0.02 - 100 | --- | --- | --- | --- | --- | 2 or 3 poles breaking single phase | | |
| | | | --- | --- | --- | --- | --- | --- | --- | | | |
| | 250 | 50 / 60 | 1 | 0.02 - 100 | --- | --- | --- | --- | --- | --- | | |
| 3 | | | 0.02 - 70 | --- | --- | --- | --- | --- | --- | | | |
| 277 | 50 / 60 | 1 | 0.02 - 50 | --- | --- | --- | --- | --- | | | | |
| 480/277 | 50 / 60 | 3 | 0.02 - 30 | --- | 31 - 50 | --- | --- | --- | --- | 3 poles breaking 3 phase | | |
| | | | --- | --- | | | --- | --- | --- | | | |

Notes:
 1. Requires branch circuit backup with a UL LISTED Type K5 or RK5 fuse rated 15A minimum and no more than 4 times full load amps not to exceed 125A for 50 Amp or less rating and not to exceed 175 for 51 through 100 Amp rating

Electrical Tables

Table B: Lists UL Recognized and CSA Accepted configurations and performance capabilities as a Manual Motor Controller.

| C-SERIES TABLE B: Manual Motor Controllers | | | | | |
|--|------------------|-----------|-----------|----------------|--------------------|
| Circuit Configuration | Voltage | | | Current Rating | Horsepower Ratings |
| | Max. Rating | Frequency | Phase | Full Load Amps | Max. HP |
| Series, Shunt & Relay Switch Only | 120 ¹ | 50 / 60 | 1 | 0.02 - 50 | 7 1/2 |
| | 250 ¹ | 50 / 60 | 1 | 0.02 - 20 | 3 |
| | | | 3 | 0.02 - 20 | 5 |
| | 277 ¹ | 50 / 60 | 1 | 0.02 - 20 | 3 |
| 480 ² | 50 / 60 | 3 | 0.02 - 20 | 5 | |

- Notes:
- Requires branch circuit backup with a UL Listed Type K5 or RK5 fuse rated 15A Minimum and no more than 4 times full load amps not to exceed 125A for 50 Amp or less rating and not to exceed 175A for 51 through 100A rating.
 - UL Recognized and CSA Certified at 480V refers to 3 and 4 pole versions used in a 3Ø, WYE connected circuit or a 2 pole version with 2 poles breaking 1Ø and backed up with a series fusing as stated in note 1.
- * Shunt and Relay Trip - Voltage Coil Construction not current coils

Table C: Lists UL Recognized, CSA Accepted, VDE and TUV Certified configurations and performance capabilities as a Component Supplementary Protector.

| C-SERIES TABLE C: Component Supplementary Protectors | | | | | | | | | | | | | | |
|--|-------------|-----------|-----------------------------|----------------|-----------------------------------|-------------------------------|---------------------|------------------------|---------------------------|------------------------|---------------------------|-------------------------------|-----------------------------|---------------------|
| Circuit Configuration | Voltage | | | Current Rating | | Short Circuit Capacity (Amps) | | | | | | Application Codes UL / CSA | Construction Notes | |
| | Max. Rating | Frequency | Phase | Full Load Amps | General Purpose Amps ¹ | UL / CSA | | VDE | | TUV | | | | |
| | | | | | | With Backup Fuse | Without Backup Fuse | (Inc) With Backup Fuse | (Inc) Without Backup Fuse | (Inc) With Backup Fuse | (Inc) Without Backup Fuse | | | |
| Series | 80 | DC | --- | 0.10 - 70 | --- | --- | 7,500 | --- | 5,000 | 5,000 | 1,500 | TC1,2,OL1,U1 | --- | |
| | | | | 71 - 100 | 71 - 100 | --- | 10,000 | --- | 5,000 | --- | 5,000 | | 5,000 | Agency F, H, J or R |
| | 250 | 50 / 60 | 1 | 0.10 - 50 | --- | --- | 5,000 | --- | --- | --- | --- | 5,000 | TC1,2,OL1,U1 | 2P, Agency J or R |
| | | | | 0.10 - 70 | --- | --- | | | --- | --- | --- | --- | | |
| | | | | 0.10 - 100 | --- | --- | | | --- | --- | --- | --- | | |
| | | | | 0.10 - 90 | --- | --- | | | --- | --- | --- | --- | | 5,000 |
| 415 | 50 / 60 | 3 | 0.10 - 30 | --- | 5,000 ² | --- | --- | 3,000 | 1,500 | 3,000 | 1,500 | TC1,2,OL1,C1 | Rocker | |
| | | | | | | | --- | 5,000 | 2,500 | | | | Handle, Agency F, H, J or R | |
| Dual Coil | 80 | DC | --- | 0.10 - 30 | --- | --- | 7,500 | --- | 1,500 | 5,000 | 1,500 | TC1,2,OL1,U1 | --- | |
| | 250 | 50 / 60 | 1 & 3 | | | | 5,000 | 3,000 | | 3,000 | | | | |
| Shunt | 80 | DC | --- | 0.10 - 70 | --- | --- | 7,500 | --- | 5,000 | 5,000 | 1,500 | TC1,2,OL1,U1 | --- | |
| | 250 | 50 / 60 | 1 & 3 | 0.10 - 70 | --- | --- | 5,000 | 3,000 | 1,500 | 3,000 | 1,500 | TC1,2,OL1,U1 | --- | |
| | 415 | 50 / 60 | 3 | 0.10 - 30 | --- | 5,000 ² | --- | 3,000 | 1,500 | 3,000 | 1,500 | TC1,2,OL1,C1 | Rocker | |
| --- | 5,000 | 2,500 | Handle, Agency F, H, J or R | | | | | | | | | | | |

- Notes:
- General Purpose ratings for UL/CSA only.
 - Requires branch circuit backup with a UL LISTED Type K5 or RK5 fuse rated 15A minimum and no more than 4 times full load amps not to exceed 125A for 50 Amp or less rating and not to exceed 175 for 51 through 100 Amp rating.

Table D: Lists UL Listed (489), CSA Certified (C22.2 No. 5.1-M) configuration and performance capabilities as a Molded Case Circuit Breaker.

| C-SERIES TABLE D: UL489 Listed Branch Circuit Breakers | | | | | | | |
|--|-------------|-----------|-----------|----------------|------------------------------|--------|---|
| Circuit Configuration | Voltage | | | Current Rating | Interrupting Capacity (Amps) | | Construction Notes |
| | Max. Rating | Frequency | Phase | Full Load Amps | Without Backup Fuse | | |
| Series | 80 | DC | --- | 0.10 - 100 | 50,000 ¹ | | Limited to 2 Poles Max from 71 - 100 Amps |
| | | | | | 10,000 | | |
| | | | | | 10,000 | | |
| | 125 | DC | --- | 0.10 - 100 | 5,000 | | 1 - 3 Poles |
| | | | | | 5,000 | | 1 or 2 Poles (2 poles required for 250 Volts) |
| | 120 | 50 / 60 | 1 | 0.10 - 50 | 10,000 | | 1 - 3 Poles |
| | | | | | 5,000 | | |
| | 120 / 240 | 50 / 60 | 1 | 0.10 - 50 | 5,000 | | 2 or 3 Poles (1 pole of a 3 pole unit is neutral) |
| | | | | | 10,000 ¹ | | |
| | 240 | 50 / 60 | 1 | 0.10 - 30 | 5,000 | | 1 Pole |
| 10,000 | | | | | 2 Poles | | |
| 277 | 50 / 60 | 1 | 0.10 - 20 | 10,000 | | 1 Pole | |
| Dual Coil | 120 | 50 / 60 | 1 | 0.10 - 30 | 10,000 | | --- |

- Notes:
- Special catalog number required. Consult factory.

Electrical Tables

Table E: Lists UL Recognized, CSA Accepted configurations and performance capabilities as Protectors, Supplementary for Marine Electrical and Fuel Systems (Guide PEQZ2, File E75596). Ignition Protected per UL 1500. UL Classified Small Craft Electrical Devices, Marine in accordance with ISO 8846 (Guide UZMK, File MQ1515) as Marine Supplementary Protectors.

| C-SERIES TABLE E: UL1500 (Marine Ignition Protection) | | | | | | | | |
|---|-------------|-----------|-------|----------------|------------------------------|-------------------|-----------------|-------------------------------|
| Circuit Configuration | Voltage | | | Current Rating | Interrupting Capacity (Amps) | Application Codes | | Construction Notes |
| | Max. Rating | Frequency | Phase | Full Load Amps | Without Backup Fuse | UL | CSA | |
| Series | 48 | DC | --- | 0.02 - 100 | 5,000 | TC1, 2, OL1, U1 | TC1, 2, OL1, U1 | --- |
| | | | | 101 - 150 | | | | |
| | 65 | DC | --- | 0.02 - 100 | 1,500 | TC1, 2, OL0, U1 | TC1, 2, OL0, U1 | --- |
| | 80 | DC | --- | 0.02 - 70 | 1,500 | TC1, 2, OL1, U1 | TC1, 2, OL1, U1 | --- |
| | 125 | 50 / 60 | 1 | 0.02 - 70 | 5,000 | TC1, 2, OL1, U1 | TC1, 2, OL1, U1 | --- |
| | | | | 71 - 100 | 1,500 | | | |
| | 250 | 50 / 60 | 1 | 0.02 - 70 | 1,500 | TC1, 2, OL1, U1 | TC1, 2, OL1, U1 | --- |
| | | | | 71 - 100 | | | | 2 Poles Breaking Single Phase |

Table F: Lists UL Listed configurations and performance capabilities as Circuit Breakers for use in Communications Equipment (Guide DITT, File E189195), under UL489A.

| C-SERIES TABLE F: PARALLEL POLE CONSTRUCTION UL489A Listed for Communications Equipment | | | | |
|--|-------------|-----------|----------------------|------------------------------|
| Circuit Configuration | Voltage | | Current Rating | Interrupting Capacity (Amps) |
| | Max. Rating | Frequency | General Purpose Amps | Without Backup Fuse |
| Series | 80 | DC | 100 - 250 | 10,000 |

Agency Certifications

UL Recognized

UL Standard 1077



Component Recognition Program as Protectors Supplementary (Guide CCN/QVNU2, File E75596)

CSA Accepted



Component Supplementary Protector under Class 3215 30, File 047848 0 000 CSA Standard C22.2 No. 235

UL Standard 508



Switches, Industrial Control (Guide CCN/NRNT2, File E148683)

CSA Certified



Circuit Breaker Model Case (Class 1432 01, File 093910), CSA Standard C22.2 No. 5.1 - M

UL Standard 1500



Protectors, Supplementary for Marine Electrical & Fuel Systems (Guide PEQZ2, File E75596) Ignition Protection

TUV Certified



EN60934, under License No. R72040875

UL Listed

UL Standard 489



Circuit Breakers, Molded Case, (Guide DIVQ, File E129899)

VDE Certified



EN60934, VDE 0642 under File No. 10537

UL Standard 489A



Communications Equipment (Guide CCN/DITT, File E189195)



1 SERIES

C

2 ACTUATOR ¹

- A** Handle, one per pole
- B** Handle, one per multipole unit
- S** Mid-Trip Handle, one per pole
- T** Mid-Trip Handle, one per pole & Alarm Switch

3 POLES ²

- | | | |
|--------------|----------------|---------------|
| 1 One | 3 Three | 5 Five |
| 2 Two | 4 Four | 6 Six |

4 CIRCUIT ³

- | | |
|---|--|
| A ³ Switch Only (No Coil) | F ⁴ Relay Trip (Current) |
| B Series Trip (Current) | G ⁴ Relay Trip (Voltage) |
| C Series Trip (Voltage) | H ^{4,5} Dual Coil with Shunt Trip Voltage Coil |
| D ⁴ Shunt Trip (Current) | K ^{4,5} Dual Coil with Relay Trip Voltage Coil |
| E ⁴ Shunt Trip (Voltage) | |

5 AUXILIARY / ALARM SWITCH

- | | |
|---|-------------------------------------|
| 0 without Aux Switch | 6 S.P.S.T., 0.139 Solder Lug |
| 2 S.P.D.T., 0.110 Q.C. Term. | 8 S.P.S.T., 0.187 Q.C. Term. |
| 3 S.P.D.T., 0.139 Solder Lug | 9 S.P.D.T., 0.187 Q.C. Term. |
| 4 S.P.D.T., 0.110 Q.C. Term. (Gold Contacts) | |

6 FREQUENCY & DELAY

- | | |
|--|--|
| 03 ³ DC 50/60Hz, Switch Only | 30 DC 50/60Hz Instantaneous |
| 10 ⁷ DC Instantaneous | 31 DC 50/60Hz Ultra Short |
| 11 DC Ultra Short | 32 DC 50/60Hz Short |
| 12 DC Short | 34 DC 50/60Hz Medium |
| 14 DC Medium | 36 DC 50/60Hz Long |
| 16 DC Long | 42 ⁸ 50/60Hz Short, Hi-Inrush |
| 20 ⁷ 50/60Hz Instantaneous | 44 ⁸ 50/60Hz Medium, Hi-Inrush |
| 21 50/60Hz Ultra Short | 46 ⁸ 50/60Hz Long, Hi-Inrush |
| 22 50/60Hz Short | 52 ⁸ DC Short, Hi-Inrush |
| 24 50/60Hz Medium | 54 ⁸ DC Medium, Hi-Inrush |
| 26 50/60Hz Long | 56 DC Long, Hi-Inrush |

Notes:

- 1 Actuator Code:
A: Handle tie pin spacer(s) and retainers provided assembled with multi-pole units.
B: Handle location as viewed from front of breaker:
2 pole - left pole 3 pole - center pole 4 pole - two handles at center poles
5 pole - three handles at center poles 6 pole - four handles at center poles
S: Handle moves to mid-position only upon electrical trip of the breaker. Available with circuit codes B, C, D, E, F, G, H and K.
T: Handle moves to mid-position and alarm switch activates only upon electrical trip of the breaker. Available with circuit codes B & C.
- 2 Standard multipole units have all poles identical except when specifying auxiliary switch and/or mixed poles. 4 pole max with VDE. 5th pole available as Series Trip with Voltage Coil only.
- 3 Switch Only circuits, rated up to 50 amps and 6 poles, and only available with VDE Certification when tied to a protected pole (Circuit Code B, C, D or H.). For .02 to 30 amps, select Current Code 630. For 35 - 50 amps, select Current Code 650. For 55-70 amps, select Current Code 670. For 75-100 amps, select Current Code 810. Circuit Codes D,E,F,G,H & K available with Terminal Codes 1,2,4 & 5 only. Circuit Codes D, F, H & K available up to 50 amps maximum Current Rating.
- 5 Consult factory for available Dual Coil options, as special catalog number is required. Dual Coil Voltage Coils with Shunt Trip Construction trip instantaneously on line voltage. Dual Coil Voltage Coils require 30VA minimum power to trip instantaneously and are rated for intermittent duty only.
- 6 Auxiliary Switch available with Series Trip and Switch Only circuits. On multi-pole breakers, one auxiliary switch is supplied, mounted in the extreme right pole.
- 7 Voltage coils not rated for continuous duty. Available only with delay codes 10 & 20.
- 8 Available with Circuit Codes B & D only, and up to 50 amps maximum.
- 9 Current Ratings 60 - 70 are available up to four poles maximum. Ratings 71 - 100 are available up to two poles maximum.
- 10 Terminal Code 1 available to 60 amps maximum.
- 11 Terminal Codes 2, 4, 5 and C available to 50 amps maximum.
- 12 Terminal Codes 3, 6 & 9 available to 100 amps maximum.
- 13 Terminal Code 7 available to 25 amps maximum.
- 14 Terminal Code A available to 100 amps maximum.
- 15 Terminal Codes 7, 9 & C are not VDE approved.
- 16 No marking available. Consult factory. VDE/TUV Approval requires dual (I-O, ON-OFF) or I-O markings on all handles.
- 17 Single pole only.
- 18 VDE/TUV: 30 amps max.; UL/CSA: 50 amps max.; Available in 2 - 4 poles only and limited to AC Delays. "General Purpose amps" not rated for "full load amps" or to be used in applications with a motor.

7 CURRENT RATING (AMPERES)

| CODE | AMPERES | CODE | AMPERES | CODE | AMPERES | CODE | AMPERES |
|------|---------|------|---------|------|---------|------|---------|
| 020 | 0.020 | 235 | 0.350 | 430 | 3.000 | 614 | 14.000 |
| 025 | 0.025 | 240 | 0.400 | 435 | 3.500 | 615 | 15.000 |
| 030 | 0.030 | 245 | 0.450 | 440 | 4.000 | 616 | 16.000 |
| 035 | 0.035 | 250 | 0.500 | 445 | 4.500 | 617 | 17.000 |
| 040 | 0.040 | 255 | 0.550 | 450 | 5.000 | 618 | 18.000 |
| 045 | 0.045 | 260 | 0.600 | 455 | 5.500 | 620 | 20.000 |
| 050 | 0.050 | 265 | 0.650 | 460 | 6.000 | 622 | 22.000 |
| 055 | 0.055 | 270 | 0.700 | 465 | 6.500 | 624 | 24.000 |
| 060 | 0.060 | 275 | 0.750 | 470 | 7.000 | 625 | 25.000 |
| 065 | 0.065 | 280 | 0.800 | 475 | 7.500 | 630 | 30.000 |
| 070 | 0.070 | 285 | 0.850 | 480 | 8.000 | 635 | 35.000 |
| 075 | 0.075 | 290 | 0.900 | 485 | 8.500 | 640 | 40.000 |
| 080 | 0.080 | 295 | 0.950 | 490 | 9.000 | 650 | 50.000 |
| 085 | 0.085 | 410 | 1.000 | 495 | 9.500 | 660 | 60.000 |
| 090 | 0.090 | 512 | 1.250 | 610 | 10.000 | 670 | 70.000 |
| 095 | 0.095 | 415 | 1.500 | 710 | 10.500 | 680 | 80.000 |
| 210 | 0.100 | 517 | 1.750 | 611 | 11.000 | 685 | 85.000 |
| 215 | 0.150 | 420 | 2.000 | 711 | 11.500 | 690 | 90.000 |
| 220 | 0.200 | 522 | 2.250 | 612 | 12.000 | 695 | 95.000 |
| 225 | 0.250 | 425 | 2.500 | 712 | 12.500 | 810 | 100.000 |
| 230 | 0.300 | 527 | 2.750 | 613 | 13.000 | | |

OR VOLTAGE COIL (NORMAL RATED VOLTAGE) ⁷

| CODE | AMPERES | CODE | VOLTAGE | CODE | VOLTAGE | CODE | VOLTAGE |
|------|---------|------|---------|------|---------|------|---------|
| A06 | 6 DC | A32 | 32 DC | J12 | 12 AC | J65 | 65 AC |
| A12 | 12 DC | A48 | 48 DC | J18 | 18 AC | K20 | 120 AC |
| A18 | 18 DC | A65 | 65 DC | J24 | 24 AC | L40 | 240 AC |
| A24 | 24 DC | J06 | 6 AC | J48 | 48 AC | | |

8 TERMINAL ¹⁵

- | | |
|---------------------------------------|--|
| 1 ¹⁰ Stud 10-32 | 6 ¹² Stud M6 |
| 2 ¹¹ Screw 10-32 | 7 ^{13,15} 0.250 Double Click Connect |
| 3 ¹² Stud 1/4-20 | 9 ¹⁵ 7/16" Clip Terminal |
| 4 ¹¹ Stud M5 x 0.8 | A ¹⁴ Plug-In Stud |
| 5 ¹¹ Screw M5 x 0.8 | C ^{11,15} 5/16" Clip Terminal |

9 ACTUATOR COLOR & LEGEND ¹⁶

| Actuator Color | I-O | ON-OFF | Dual | Legend Color |
|------------------------------------|-----|--------|------|--------------|
| White | A | B | 1 | Black |
| Black | C | D | 2 | White |
| Red | F | G | 3 | White |
| Green | H | J | 4 | White |
| Blue | K | L | 5 | White |
| Yellow | M | N | 6 | Black |
| Gray | P | Q | 7 | Black |
| Orange | R | S | 8 | Black |
| Black (short handle) ¹⁷ | T | U | 9 | White |

10 MOUNTING / BARRIERS

| MOUNTING STYLE | BARRIERS | VOLTAGE |
|--|----------|---------|
| Threaded Insert | | |
| 1 6-32 x 0.195 inches | no | < 300 |
| A 6-32 X 0.195 inches | yes | < 300 |
| C 18 6-32 X 0.195 inches | yes | ≥ 300 |
| 2 ISO M3 x 5mm | no | < 300 |
| B ISO M3 x 5mm | yes | < 300 |
| D 18 ISO M3 x 5mm | yes | ≥ 300 |
| Front panel Snap-In, 1.00" [25.4mm] wide bezel with Handleguard | no | < 300 |

11 AGENCY APPROVAL

- C** UL Recognized, CSA Accepted
- D** VDE Certified, UL Recognized, CSA Accepted
- E** TUV Certified, UL Recognized, CSA Accepted
- H** UL489 Construction: VDE Certified, UL Recognized, CSA Accepted
- I** UL Recognized STD 1077, UL Recognized 1500 (ignition protected), CSA Accepted
- L** UL489 Construction: UL Recognized, CSA Accepted
- R** UL489 Construction: TUV Certified, UL Recognized, CSA Accepted

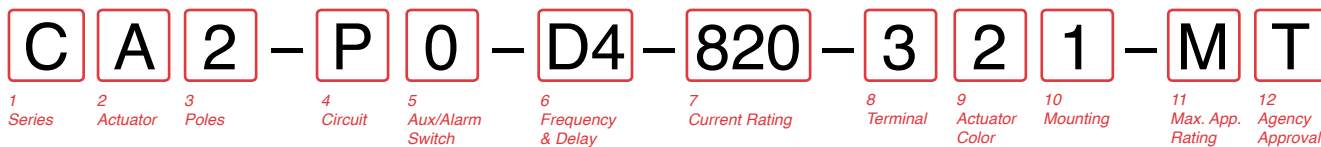

1 SERIES
C

2 ACTUATOR
A Handle, one per pole
S Mid-Trip Handle, one per pole ¹
T Mid-Trip, one per pole & Alarm Switch ¹

3 POLES ⁴
1 One
2 Two
3 Three

4 CIRCUIT
P Series Trip (parallel pole)

5 AUXILIARY / ALARM SWITCH
0 without Aux Switch 6 S.P.S.T., 0.139 Solder Lug
2 S.P.D.T., 0.110 Q.C. Term. 7 S.P.S.T., 0.110 Q.C
3 S.P.D.T., 0.139 Solder Lug Term. (Gold Contacts)
4 S.P.D.T., 0.110 Q.C. Term. 8 S.P.S.T., 0.187 Q.C. Term.
(Gold Contacts) 9 S.P.D.T., 0.187 Q.C. Term.
5 S.P.S.T., N.O., 0.110 Q.C Term. (Gold Contacts)

6 FREQUENCY & DELAY
D1 DC Ultra Short
D2 DC Short
D4 DC Medium
D6 DC Long

7 CURRENT RATING (AMPERES) ⁴

| CODE | AMPERES | | | | |
|------|---------|-----|--------|-----|--------|
| 810 | 100.00 | 813 | 130.00 | 817 | 170.00 |
| 811 | 110.00 | 814 | 140.00 | 818 | 180.00 |
| 812 | 120.00 | 815 | 150.00 | 819 | 190.00 |
| 813 | 130.00 | | | | |
| 814 | 140.00 | | | | |
| 815 | 150.00 | | | | |
| 816 | 160.00 | | | | |
| 817 | 170.00 | | | | |
| 818 | 180.00 | | | | |
| 819 | 190.00 | | | | |
| 820 | 200.00 | | | | |
| 821 | 210.00 | | | | |
| 822 | 225.00 | | | | |
| 823 | 240.00 | | | | |
| 824 | 250.00 | | | | |

8 TERMINAL ⁵
3 1/4-20 threaded Stud
6 M6 threaded Stud
A Plug-In Stud ³

9 ACTUATOR COLOR ²

| LEGEND | ON-OFF | Dual | Legend Color |
|--------|--------|------|--------------|
| White | B | 1 | Black |
| Black | D | 2 | White |
| Red | G | 3 | White |
| Green | J | 4 | White |
| Blue | L | 5 | White |
| Yellow | N | 6 | Black |
| Gray | Q | 7 | Black |
| Orange | S | 8 | Black |

10 MOUNTING
Threaded Insert
1 6-32 x 0.195 inches
2 ISO M3 x 5mm

11 MAXIMUM APPLICATION RATING
M 80 DC

12 AGENCY APPROVAL ⁶
A Without Approval
G UL489 Listed
J UL489A Listed, TUV Certified
K UL489A Listed, VDE Certified
T UL489A Listed
7 UL489A Listed, TUV Certified

- Notes:
- Handle moves to Mid-Position only upon electrical trip of C/B when Actuator S is specified. When Actuator Code T is specified, handle moves to Mid Position and Alarm Switch actuates only upon electrical trip of C/B. Code T is only available with Circuit Code N.
 - Standard Handle colors are White, Black, Red & Yellow.
 - Breakers with Terminal Codes 3 & 6 are supplied with bus bars connecting the Line and Load Terminals. For Terminal Code A, Line and Load Terminals must be connected to a copper bus bar having a minimum cross-section of 0.078 square inches. Terminal Code A is not available on the single pole unit.
Ratings for 101 to 125 amps are available in 1-pole.
Ratings from 110 to 200 amps are available in 2-pole.
For ratings from 225-300 amps, specify 3-pole.
 - 1 pole only available with terminal codes 3 and 6.
 - Agency codes K and 7 are not available with 1 pole.
Agency code J is only available with 1 pole.
Agency code G is only available in 2 and 3 pole.
 - Circuit P, ratings 101-150 amps (2 pole) and ratings 151-250 amps (3 pole).

C A 3 - B 0 - 14 - 450 - 1 2 1 - K G

1 *Series* 2 *Actuator* 3 *Poles* 4 *Circuit* 5 *Aux/Alarm Switch* 6 *Frequency & Delay* 7 *Current Rating* 8 *Terminal* 9 *Actuator Color* 10 *Mounting/ Barriers* 11 *Max. App. Rating* 12 *Agency Approval*

1 SERIES
C

2 ACTUATOR 1
A Handle, one per pole
B Handle, one per multipole unit
S Mid-Trip Handle, one per pole
T Mid-Trip Handle, one per pole & Alarm Switch

3 POLES 2

| | | |
|--------------|--------------|----------------|
| 1 One | 2 Two | 3 Three |
|--------------|--------------|----------------|

4 CIRCUIT
B Series Trip (Current)

5 AUXILIARY / ALARM SWITCH 3

| | |
|--|-------------------------------------|
| 0 without Aux Switch | 6 S.P.D.T., 0.139 Solder Lug |
| 2 S.P.D.T., 0.110 Q.C. Term. | 8 S.P.S.T., 0.187 Q.C. Term. |
| 3 S.P.D.T., 0.139 Solder Lug | 9 S.P.D.T., 0.187 Q.C. Term. |
| 4 S.P.D.T., 0.110 Q.C. Term. (Gold Contacts) | |

6 FREQUENCY & DELAY

| | |
|-------------------------------|---------------------------------------|
| 11 DC Ultra Short | 26 50/60Hz Long |
| 12 DC Short | 42 4 50/60Hz Short, Hi-Inrush |
| 14 DC Medium | 44 4 50/60Hz Medium, Hi-Inrush |
| 16 DC Long | 46 4 50/60Hz Long, Hi-Inrush |
| 21 50/60Hz Ultra Short | 52 4 DC Short, Hi-Inrush |
| 22 50/60Hz Short | 54 4 DC Medium, Hi-Inrush |
| 24 50/60Hz Medium | 56 4 DC Long, Hi-Inrush |

7 CURRENT RATING (AMPERES)

| CODE | AMPERES | 295 | 0.950 | 470 | 7.000 | 618 | 18.000 |
|------|---------|-----|-------|-----|--------|-----|--------|
| 210 | 0.100 | 295 | 0.950 | 470 | 7.000 | 618 | 18.000 |
| 215 | 0.150 | 410 | 1.000 | 475 | 7.500 | 620 | 20.000 |
| 220 | 0.200 | 512 | 1.250 | 480 | 8.000 | 622 | 22.000 |
| 225 | 0.250 | 415 | 1.500 | 485 | 8.500 | 624 | 24.000 |
| 230 | 0.300 | 517 | 1.750 | 490 | 9.000 | 625 | 25.000 |
| 235 | 0.350 | 420 | 2.000 | 495 | 9.500 | 630 | 30.000 |
| 240 | 0.400 | 522 | 2.250 | 610 | 10.000 | 635 | 35.000 |
| 245 | 0.450 | 425 | 2.500 | 710 | 10.500 | 640 | 40.000 |
| 250 | 0.500 | 527 | 2.750 | 611 | 11.000 | 660 | 60.000 |
| 255 | 0.550 | 430 | 3.000 | 711 | 11.500 | 670 | 70.000 |
| 260 | 0.600 | 435 | 3.500 | 612 | 12.000 | 680 | 80.000 |
| 265 | 0.650 | 440 | 4.000 | 712 | 12.500 | 685 | 85.000 |
| 270 | 0.700 | 445 | 4.500 | 613 | 13.000 | 690 | 90.000 |
| 275 | 0.750 | 450 | 5.000 | 614 | 14.000 | 695 | 95.000 |
| 280 | 0.800 | 455 | 5.500 | 615 | 15.000 | 810 | 100.00 |
| 285 | 0.850 | 460 | 6.000 | 616 | 16.000 | | |
| 290 | 0.900 | 465 | 6.500 | 617 | 17.000 | | |

8 TERMINAL 6

| | |
|---------------------------|--------------------------------|
| 1 7 Stud 10-32 | 6 9 Stud M6 |
| 2 8 Screw 10-32 | 9 9 7/16" Clip Terminal |
| 3 9 Stud 1/4-20 | A 10 Plug-In Stud |
| 4 8 Stud M5 x 0.8 | C 8 5/16" Clip Terminal |
| 5 8 Screw M5 x 0.8 | |

9 ACTUATOR COLOR & LEGEND 11

| Actuator Color | ON-OFF | Dual | Legend Color |
|----------------|----------|----------|--------------|
| White | B | 1 | Black |
| Black | D | 2 | White |
| Red | G | 3 | White |
| Green | J | 4 | White |
| Blue | L | 5 | White |
| Yellow | N | 6 | Black |
| Gray | Q | 7 | Black |
| Orange | S | 8 | Black |

10 MOUNTING / BARRIERS

| MOUNTING STYLE | BARRIERS 12 |
|------------------------------|-------------|
| Threaded Insert | |
| 1 6-32 x 0.195 inches | yes |
| 2 ISO M3 x 5mm | yes |

11 MAXIMUM APPLICATION RATING

| |
|-----------------------|
| A 65 DC |
| B 125 DC |
| C 120/240 AC 2 |
| D 240 AC |
| K 120 AC |
| F 277 AC |
| M 80 DC |

12 AGENCY APPROVAL 11

| |
|--|
| A without approvals |
| F UL489 Listed, CSA Certified & VDE Certified |
| G UL489 Listed & CSA Certified |
| J UL489 Listed, CSA Certified & TUV Certified |

Notes:
1 Actuator Code:
A: Handle tie pin spacer(s) and retainers provided assembled with multi-pole units.
B: Handle located, as viewed from front of breaker in left pole. 2 pole maximum.
S: Handle moves to mid-position only upon electrical trip of the breaker.
T: Handle moves to mid-position and alarm switch activates only upon electrical trip of the breaker.
2 Standard multipole units have all poles identical except when specifying auxiliary switch and/or mixed poles.
2 & 3 pole circuit breakers required for 120/240 VAC (Maximum application rating code C) applications, have all poles identical except when specifying auxiliary / alarm switch which is normally supplied in extreme right pole per figure B. Terminal barriers are required on all multipole breakers.
Third pole is for 120/240 VAC applications requiring neutral disconnect. The 3rd pole has the same construction as poles 1 & 2.
3 On multi-pole breakers, one auxiliary switch is supplied, mounted in the extreme right pole.
VDE approval on auxiliary switch codes 2, 3 & 4 only.
Auxiliary / Alarm Switch with Independent Circuit ie: separate from breaker circuit, only available with circuit breakers rated 50 amp maximum at 80 VDC, 125 VDC, and 120 VAC. Auxiliary / Alarm Switch with Dependent Circuit ie: same as circuit breaker, is supplied from factory with common terminal of auxiliary / alarm switch connected to line terminal on 120/240 and 240 VAC ratings. Circuit breakers rated 120 VAC 50 amp maximum can be supplied with Auxiliary/Alarm switch common terminal connected to breaker line terminal. Consult factory for special catalog number.
4 Available up to 50 amps maximum.
5 Current ratings 71 - 100 with VDE approvals are available up to two poles maximum.
6 Terminal Codes 9 & C are not VDE approved.
7 Terminal Code 1 available to 60 amps maximum.
8 Terminal Codes 2, 4, 5 & C available to 50 amps maximum.
9 Terminal Codes 3, 6 & 9 available to 100 amps maximum.
10 Terminal Code A available to 100 amps maximum.
11 VDE and TUV approvals require Dual (I-O, ON-OFF) markings on all handles.
12 Barriers supplied on multi-pole units only.



1 SERIES
C

2 ACTUATOR 1

Two Color Visi-Rocker

- C Indicate ON, vertical legend
- D Indicate ON, horizontal legend
- E Indicate ON, no legend
- F Indicate OFF, vertical legend
- G Indicate OFF, horizontal legend
- H Indicate OFF, no legend

Push-To-Reset, Visi-Rocker

- N Indicate OFF, vertical legend
- O Indicate OFF, horizontal legend
- P Indicate OFF, no legend

Single color

- J Vertical legend
- K Horizontal legend
- L No legend

Push-To-Reset, Single color

- R Vertical legend
- U Horizontal legend
- V No legend

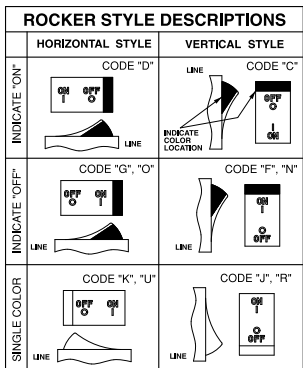

3 POLES 2

- 1 One
- 2 Two
- 3 Three

4 CIRCUIT

- A³ Switch Only (No Coil)
- B Series Trip (Current)
- C Series Trip (Voltage)
- D⁴ Shunt Trip (Current)
- E⁴ Shunt Trip (Voltage)
- F⁴ Relay Trip (Current)
- G⁴ Relay Trip (Voltage)
- H^{4,5} Dual Coil with Shunt Trip Voltage Coil
- K^{4,5} Dual Coil with Relay Trip Voltage Coil

5 AUXILIARY / ALARM SWITCH 6

- 0 without Aux Switch
- 2 S.P.D.T., 0.110 Q.C. Term.
- 3 S.P.D.T., 0.139 Solder Lug
- 4 S.P.D.T., 0.110 Q.C. Term. (Gold Contacts)
- 6 S.P.S.T., 0.139 Solder Lug
- 8 S.P.S.T., 0.187 Q.C. Term.
- 9 S.P.D.T., 0.187 Q.C. Term.

6 FREQUENCY & DELAY

- 03 DC 50/60Hz, Switch Only
- 10⁷ DC Instantaneous
- 11 DC Ultra Short
- 12 DC Short
- 14 DC Medium
- 16 DC Long
- 20⁷ 50/60Hz Instantaneous
- 21 50/60Hz Ultra Short
- 22 50/60Hz Short
- 24 50/60Hz Medium
- 26 50/60Hz Long
- 30 DC 50/60Hz Instantaneous
- 31 DC 50/60Hz Ultra Short
- 32 DC 50/60Hz Short
- 34 DC 50/60Hz Medium
- 36 DC 50/60Hz Long
- 42⁸ 50/60Hz Short, Hi-Inrush
- 44⁸ 50/60Hz Medium, Hi-Inrush
- 46⁸ 50/60Hz Long, Hi-Inrush
- 52⁸ DC Short, Hi-Inrush
- 54⁸ DC Medium, Hi-Inrush
- 56⁸ DC Long, Hi-Inrush

Notes:

- 1 Push-To-Reset actuators have OFF portion of rocker shrouded.
- 2 Multi-pole breakers have all poles identical except when specifying Auxiliary switch and/or mixed poles, and have one rocker per breaker. Rocker location as viewed from front panel: 2 pole – left pole; 3 pole – center pole.
- 3 Switch Only circuits, rated up to 50 amps and 3 poles, and only available with VDE Certification when tied to a protected pole (Circuit Code B, C, D or H.). For .02 to 30 amps, select Current Code 630. For 35 - 50 amps, select Current Code 650. For 55-70 amps, select Current Code 670. For 75-100 amps, select Current Code 810.
- 4 Circuit Codes D,E,F,G,H & K available with Terminal Codes 1,2,4 & 5 only. Circuit Codes D,F,H & K available up to 50 amps maximum Current Rating.
- 5 Consult factory for available Dual Coil options, as special catalog number is required. Dual Coil Voltage Coils with Shunt Trip Construction trip instantaneously on line voltage. Dual Coil Voltage Coils require 30VA minimum power to trip instantaneously and are rated for intermittent duty only.
- 6 Auxiliary Switch available with Series Trip and Switch Only circuits. On multi-pole breakers, one auxiliary switch is supplied, mounted in the extreme right pole. Auxiliary switch codes 2, 3 & 4 are VDE approved.
- 7 Voltage coils not rated for continuous duty. Available only with delay codes 10 & 20.
- 8 Available with Circuit Codes B & D only, and up to 50 amps maximum.
- 9 Current Ratings 60-70 are available up to four poles maximum. Ratings 71-100 are available up to two poles maximum.
- 10 Terminal Code 1 available to 60 amps maximum.
- 11 Terminal Codes 2,4,5 & C available to 50 amps maximum.
- 12 Terminal Codes 3,6 & 9 available to 100 amps maximum.
- 13 Terminal Code 7 available to 25 amps maximum.
- 14 Terminal Code A available to 100 amps maximum.
- 15 Terminal Codes 7, 9 & C are not VDE approved.
- 16 Color shown is visi and legend with remainder of rocker black
- 17 Legend on Push-to-reset bezel/shroud is white when single color rocker is ordered. Dual = ON-OFF/I-O legend with actuator codes C - G, and J, K, N, O, R, & U. None = no legend with actuator codes H, L, P, V. Rockerguard available with actuator codes C - L. Push-to-reset available with actuator codes N, O, P, R, U, V.
- 18 VDE/TUV approval requires Dual (I-O, ON-OFF) or I-O markings on rocker.
- 19 VDE/TUV: 30 amps max.; UL/CSA: 50 amps max.; Available in 2 - 4 poles only and limited to AC Delays. "General Purpose amps" not rated for "full load amps" or to be used in applications with a motor.

7 CURRENT RATING (AMPERES)

| CODE | AMPERES | | | | |
|------|---------|-----|-------|-----|--------|
| 020 | 0.020 | 235 | 0.350 | 430 | 3.000 |
| 025 | 0.025 | 240 | 0.400 | 435 | 3.500 |
| 030 | 0.030 | 245 | 0.450 | 440 | 4.000 |
| 035 | 0.035 | 250 | 0.500 | 445 | 4.500 |
| 040 | 0.040 | 255 | 0.550 | 450 | 5.000 |
| 045 | 0.045 | 260 | 0.600 | 455 | 5.500 |
| 050 | 0.050 | 265 | 0.650 | 460 | 6.000 |
| 055 | 0.055 | 270 | 0.700 | 465 | 6.500 |
| 060 | 0.060 | 275 | 0.750 | 470 | 7.000 |
| 065 | 0.065 | 280 | 0.800 | 475 | 7.500 |
| 070 | 0.070 | 285 | 0.850 | 480 | 8.000 |
| 075 | 0.075 | 290 | 0.900 | 485 | 8.500 |
| 080 | 0.080 | 295 | 0.950 | 490 | 9.000 |
| 085 | 0.085 | 410 | 1.000 | 495 | 9.500 |
| 090 | 0.090 | 512 | 1.250 | 610 | 10.000 |
| 095 | 0.095 | 415 | 1.500 | 710 | 10.500 |
| 210 | 0.100 | 517 | 1.750 | 611 | 11.000 |
| 215 | 0.150 | 420 | 2.000 | 711 | 11.500 |
| 220 | 0.200 | 522 | 2.250 | 612 | 12.000 |
| 225 | 0.250 | 425 | 2.500 | 712 | 12.500 |
| 230 | 0.300 | 527 | 2.750 | 613 | 13.000 |

OR VOLTAGE COIL (NORMAL RATED VOLTAGE) 7

| CODE | AMPERES | | | | |
|------|---------|-----|-------|-----|--------|
| A06 | 6 DC | A32 | 32 DC | J12 | 12 AC |
| A12 | 12 DC | A48 | 48 DC | J18 | 18 AC |
| A18 | 18 DC | A65 | 65 DC | J24 | 24 AC |
| A24 | 24 DC | J06 | 6 AC | J48 | 48 AC |
| | | | | J65 | 65 AC |
| | | | | K20 | 120 AC |
| | | | | L40 | 240 AC |

8 TERMINAL

- 1¹⁰ Stud 10-32
- 2¹¹ Screw 10-32
- 3¹² Stud 1/4-20
- 4¹¹ Stud M5 x 0.8
- 5¹¹ Screw M5 x 0.8
- 6¹² Stud M6
- 7¹³ 0.250 Double Quick Connect
- 9 7/16" Clip Terminal
- A¹⁴ Plug-In Stud
- C 5/16" Clip Terminal

9 ACTUATOR COLOR & LEGEND 16,17,18

| Actuator or Visi-Color | Marking: | Marking Color: | Single Color | Rocker/Handle | Visi-Rocker |
|------------------------|----------|----------------|--------------|---------------|-------------|
| Color: | I-O | ON-OFF | Dual/None | | |
| White | A | B | 1 | Black | White |
| Black | C | D | 2 | White | n/a |
| Red | F | G | 3 | White | Red |
| Green | H | J | 4 | White | Green |
| Blue | K | L | 5 | White | Blue |
| Yellow | M | N | 6 | Black | Yellow |
| Gray | P | Q | 7 | Black | Gray |
| Orange | R | S | 8 | Black | Orange |

10 MOUNTING / BARRIERS 1

| | STANDARD ROCKER BEZEL | BARRIERS | VOLTAGE |
|-----------------|----------------------------|----------|---------|
| 1 | 6-32 x 0.195 inches | no | <300 |
| 2 | 6-32 x 0.195 inches | yes | <300 |
| 3 ¹⁹ | 6-32 x 0.195 inches | yes | ≥300 |
| 4 | ISO M3 x 5mm | no | <300 |
| 5 | ISO M3 x 5mm | yes | <300 |
| 6 ¹⁹ | ISO M3 x 5mm | yes | ≥300 |
| | ROCKERGUARD BEZEL | | |
| A | 6-32 x 0.195 inches | no | <300 |
| C | 6-32 x 0.195 inches | yes | <300 |
| E ¹⁹ | 6-32 x 0.195 inches | yes | ≥300 |
| G | ISO M3 x 5mm | no | <300 |
| J | ISO M3 x 5mm | yes | <300 |
| L ¹⁹ | ISO M3 x 5mm | yes | ≥300 |
| | PUSH-TO-RESET BEZEL | | |
| B | 6-32 x 0.195 inches | no | <300 |
| D | 6-32 x 0.195 inches | yes | <300 |
| F ¹⁹ | 6-32 x 0.195 inches | yes | ≥300 |
| H | ISO M3 x 5mm | no | <300 |
| J | ISO M3 x 5mm | yes | <300 |
| M ¹⁹ | ISO M3 x 5mm | yes | ≥300 |

11 AGENCY APPROVAL

- C UL Recognized & CSA Accepted
- D VDE Certified, UL Recognized & CSA Accepted
- E TUV Certified, UL Recognized & CSA Accepted
- H UL489 Construction: VDE Certified, UL Recognized & CSA Accepted
- I UL Recognized STD 1077, UL Recognized 1500 (ignition protected), & CSA Accepted
- L UL489 Construction: UL Recognized & CSA Accepted
- R UL489 Construction: TUV Certified, UL Recognized & CSA Accepted



1 SERIES
C

2 ACTUATOR 1
Two Color Visi-Rocker **Single color**

C Indicate ON, vertical legend **J** Vertical legend
D Indicate ON, horizontal legend **K** Horizontal legend
F Indicate OFF, vertical legend
G Indicate OFF, horizontal legend

ROCKER STYLE DESCRIPTIONS

| | | | |
|------------------|-------------------------------|--------------------------------|------------------------------|
| VERTICAL STYLE | INDICATE "ON" CODE "C" | INDICATE "OFF" CODE "F" | SINGLE COLOR CODE "J" |
| | INDICATE COLOR LOCATION | | |
| HORIZONTAL STYLE | CODE "D" | CODE "G" | CODE "K" |
| | | | |

3 POLES 1
1 One 2 Two 3 Three

4 CIRCUIT
B Series Trip (current)

5 AUXILIARY / ALARM SWITCH 2

| | |
|--|------------------------------|
| 0 without Aux Switch | 6 S.P.D.T., 0.139 Solder Lug |
| 2 S.P.D.T., 0.110 Q.C. Term. | 8 S.P.S.T., 0.187 Q.C. Term. |
| 3 S.P.D.T., 0.139 Solder Lug | 9 S.P.D.T., 0.187 Q.C. Term. |
| 4 S.P.D.T., 0.110 Q.C. Term. (Gold Contacts) | |

6 FREQUENCY & DELAY

| | |
|------------------------|---|
| 11 DC Ultra Short | 42 ⁸ 50/60Hz Short, Hi-Inrush |
| 12 DC Short | 44 ⁸ 50/60Hz Medium, Hi-Inrush |
| 14 DC Medium | 46 ⁸ 50/60Hz Long, Hi-Inrush |
| 16 DC Long | 52 ⁸ DC Short, Hi-Inrush |
| 21 50/60Hz Ultra Short | 54 ⁸ DC Medium, Hi-Inrush |
| 22 50/60Hz Short | 56 DC Long, Hi-Inrush |
| 24 50/60Hz Medium | |
| 26 50/60Hz Long | |

- Notes:
- Multi-pole breakers have all breakers identical except when specifying Auxiliary switch and/or mixed poles, and have one rocker per breaker.
 - On multi-pole breakers, one auxiliary switch is supplied, mounted in the extreme right pole.
 - Available up to 50 amps maximum.
 - Current ratings 71 - 100 with VDE approvals are available up to two poles maximum.
 - Terminal Code 1 available to 60 amps maximum.
 - Terminal Codes 2, 4, 5 & C available to 50 amps maximum.
 - Terminal Codes 3, 6, 9 & A available to 100 amps maximum.
 - Terminal Codes 9 & C are not VDE approved.
 - Color shown is visi and legend with remainder of rocker black
 - Dual = ON-OFF/I-O legend on actuator.
 - VDE and TUV approval requires Dual (I-O, ON-OFF) markings on rocker.
 - Rockerguard available with all actuator codes.
 - Barriers supplied on multi-pole units only.
 - 2 & 3 pole circuit breakers required for 120/240 AC rating.

7 CURRENT RATING (AMPERES) 4

| CODE | AMPERES | CODE | AMPERES | CODE | AMPERES | CODE | AMPERES |
|------|---------|------|---------|------|---------|------|---------|
| 210 | 0.100 | 295 | 0.950 | 470 | 7.000 | 618 | 18.000 |
| 215 | 0.150 | 410 | 1.000 | 475 | 7.500 | 620 | 20.000 |
| 220 | 0.200 | 512 | 1.250 | 480 | 8.000 | 622 | 22.000 |
| 225 | 0.250 | 415 | 1.500 | 485 | 8.500 | 624 | 24.000 |
| 230 | 0.300 | 517 | 1.750 | 490 | 9.000 | 625 | 25.000 |
| 235 | 0.350 | 420 | 2.000 | 495 | 9.500 | 630 | 30.000 |
| 240 | 0.400 | 522 | 2.250 | 610 | 10.000 | 635 | 35.000 |
| 245 | 0.450 | 425 | 2.500 | 710 | 10.500 | 640 | 40.000 |
| 250 | 0.500 | 527 | 2.750 | 611 | 11.000 | 650 | 50.000 |
| 255 | 0.550 | 430 | 3.000 | 711 | 11.500 | 660 | 60.000 |
| 260 | 0.600 | 435 | 3.500 | 612 | 12.000 | 670 | 70.000 |
| 265 | 0.650 | 440 | 4.000 | 712 | 12.500 | 680 | 80.000 |
| 270 | 0.700 | 445 | 4.500 | 613 | 13.000 | 685 | 85.000 |
| 275 | 0.750 | 450 | 5.000 | 614 | 14.000 | 690 | 90.000 |
| 280 | 0.800 | 455 | 5.500 | 615 | 15.000 | 695 | 95.000 |
| 285 | 0.850 | 460 | 6.000 | 616 | 16.000 | 810 | 100.00 |
| 290 | 0.900 | 465 | 6.500 | 617 | 17.000 | | |

8 TERMINAL

| | |
|---|--------------------------------------|
| 1 ⁵ Stud 10-32 | 6 ⁷ Stud M6 |
| 2 ⁶ Screw 10-32 with saddle & washer clamps | 9 ^{7,8} 7/16" Clip Terminal |
| 3 ⁷ Stud 1/4-20 | A ^{7,8} Plug-In Stud |
| 4 ⁶ Stud M5 x 0.8 | C ^{6,8} 5/16" Clip Terminal |
| 5 ⁶ Screw M5 x 0.8 with saddle & washer clamps | |

9 ACTUATOR COLOR & LEGEND 11

| Actuator or Visi-Color | Marking: | Marking Color: | Single Color | Rocker/Handle | Visi-Rocker |
|------------------------|----------|----------------|--------------|---------------|-------------|
| White | B | 1 | Black | Black | White |
| Black | D | 2 | White | White | n/a |
| Red | G | 3 | White | White | Red |
| Green | J | 4 | White | White | Green |
| Blue | L | 5 | White | White | Blue |
| Yellow | N | 6 | Black | Black | Yellow |
| Gray | Q | 7 | Black | Black | Gray |
| Orange | S | 8 | Black | Black | Orange |

10 MOUNTING / BARRIERS 12

| | Standard Rocker Bezel Threaded Insert, 2 per pole | BARRIERS 13 |
|---|---|-------------|
| A | 6-32 X 0.195 inches | yes |
| C | ISO M3 x 5mm | yes |
| | Rockerguard Bezel Threaded Insert, 2 per pole | |
| B | 6-32 x 0.195 inches | yes |
| D | ISO M3 x 5mm | yes |

11 MAXIMUM APPLICATION RATING

| | |
|---|---------------|
| A | 65 DC |
| B | 125 DC |
| C | 120/240 AC 14 |
| D | 240 AC |
| F | 277 AC |
| K | 120 AC |
| M | 80 DC |

12 AGENCY APPROVAL

| | |
|---|---|
| A | without approvals |
| F | UL 489 Listed, CSA Certified, & VDE Certified |
| G | UL 489 Listed & CSA Certified |
| J | UL489 Listed, CSA Certified & TUV Certified |

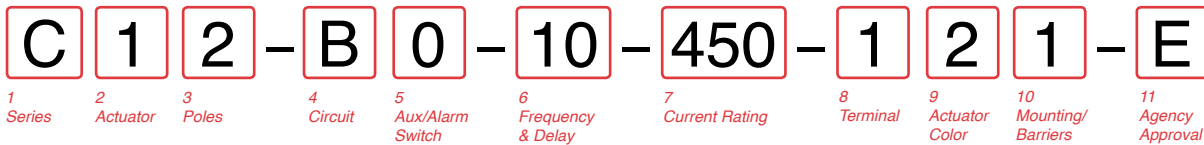

1 SERIES
C

2 ACTUATOR 1

Two Color Visi-Rocker

- 1 Indicate OFF, vertical legend
- 2 Indicate OFF, horizontal legend

Single color

- 3 Vertical legend
- 4 Horizontal legend

Push-To-Reset, Visi-Rocker

- 5 Indicate OFF, vertical legend
- 6 Indicate OFF, horizontal legend

Push-To-Reset, Single color

- 7 Vertical legend
- 8 Horizontal legend

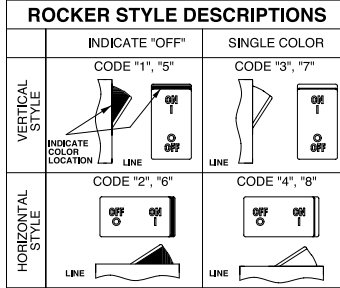

3 POLES 2

- 1 One
- 2 Two
- 3 Three

4 CIRCUIT

- A³ Switch Only (No Coil)
- B Series Trip (Current)
- C Series Trip (Voltage)
- D⁴ Shunt Trip (Current)
- E⁴ Shunt Trip (Voltage)
- F⁴ Relay Trip (Current)
- G⁴ Relay Trip (Voltage)
- H^{4,5} Dual Coil with Shunt Trip Voltage Coil
- K^{4,5} Dual Coil with Relay Trip Voltage Coil

5 AUXILIARY / ALARM SWITCH 6

- 0 without Aux Switch
- 2 S.P.D.T., 0.110 Q.C. Term.
- 3 S.P.D.T., 0.139 Solder Lug
- 4 S.P.D.T., 0.110 Q.C. Term. (Gold Contacts)
- 6 S.P.S.T., 0.139 Solder Lug
- 8 S.P.S.T., 0.187 Q.C. Term.
- 9 S.P.D.T., 0.187 Q.C. Term.

6 FREQUENCY & DELAY

- 03 DC 50/60Hz, Switch Only
- 10 7 DC Instantaneous
- 11 DC Ultra Short
- 12 DC Short
- 14 DC Medium
- 16 DC Long
- 20 7 50/60Hz Instantaneous
- 21 50/60Hz Ultra Short
- 22 50/60Hz Short
- 24 50/60Hz Medium
- 26 50/60Hz Long
- 30 DC 50/60Hz Instantaneous
- 31 DC 50/60Hz Ultra Short
- 32 DC 50/60Hz Short
- 34 DC 50/60Hz Medium
- 36 DC 50/60Hz Long
- 42 8 50/60Hz Short, Hi-Inrush
- 44 8 50/60Hz Medium, Hi-Inrush
- 46 8 50/60Hz Long, Hi-Inrush
- 52 8 DC Short, Hi-Inrush
- 54 8 DC Medium, Hi-Inrush
- 56 8 DC Long, Hi-Inrush

Notes:

- 1 Push-to-reset actuators have OFF portion of rocker shrouded.
- 2 Multi-pole breakers have all poles identical except when specifying Auxiliary switch and/or mixed poles, and have one rocker per breaker. Rocker location as viewed from front panel: 2 pole – left pole; 3 pole – center pole.
- 3 Switch Only circuits, rated up to 50 amps and 3 poles, and only available with VDE Certification when tied to a protected pole (Circuit Code B, C, D or H.). For .02 to 30 amps, select Current Code 630. For 35 - 50 amps, select Current Code 650. For 55-70 amps, select Current Code 670. For 75-100 amps, select Current Code 810.
- 4 Circuit Codes D,E,F,G,H & K available with Terminal Codes 1,2,4 & 5 only. Circuit Codes D,F,H & K available up to 50 amps maximum Current Rating.
- 5 Consult factory for available Dual Coil options, as special catalog number is required. Dual Coil Voltage Coils with Shunt Trip Construction trip instantaneously on line voltage. Dual Coil Voltage Coils require 30VA minimum power to trip instantaneously and are rated for intermittent duty only.
- 6 Auxiliary Switch available with Series Trip and Switch Only circuits. On multi-pole breakers, one auxiliary switch is supplied, mounted in the extreme right pole. Auxiliary switch codes 2, 3 & 4 are VDE approved.
- 7 Voltage coils not rated for continuous duty. Available only with delay codes 10 and 20.
- 8 Available with Circuit Codes B & D only, and up to 50 amps maximum.
- 9 Current ratings 60-70 are available up to four poles maximum. Current ratings 71 - 100 are available up to two poles maximum.
- 10 Terminal Code 1 available to 60 amps maximum.
- 11 Terminal Codes 2,4,5 & C available to 50 amps maximum.
- 12 Terminal Codes 3,6 & 9 available to 100 amps maximum.
- 13 Terminal Code 7 available to 25 amps maximum.
- 14 Terminal Code A available to 100 amps maximum.
- 15 Terminal Codes 7, 9 & C are not VDE approved.
- 16 Color shown is visi & legend with remainder of rocker black. Dual = ON-OFF/I-O legend.
- 17 Legend on Push-to-reset bezel/shroud is white with single color actuator codes 7 & 8. Legend on Push-to-reset bezel/shroud matches visi-color of rocker with actuator codes 5 & 6.
- 18 VDE/TUV approval requires Dual (I-O, ON-OFF) or I-O markings on rocker.
- 19 VDE/TUV: 30 amps max.; UL/CSA: 50 amps max.; Available in 2 & 3 poles only and limited to AC Delays. "General Purpose amps" not rated for "full load amps" or to be used in applications with a motor.
- 20 Recessed "OFF SIDE" available with actuator codes 1,2,3&4. Legends on rocker are available in ink stamping only.

7 CURRENT RATING (AMPERES) 9

| CODE | AMPERES | 235 | 0.350 | 430 | 3.000 | 614 | 14.000 |
|------|---------|-----|-------|-----|--------|------------------|--------|
| 020 | 0.020 | 235 | 0.350 | 430 | 3.000 | 614 | 14.000 |
| 025 | 0.025 | 240 | 0.400 | 435 | 3.500 | 615 | 15.000 |
| 030 | 0.030 | 245 | 0.450 | 440 | 4.000 | 616 | 16.000 |
| 035 | 0.035 | 250 | 0.500 | 445 | 4.500 | 617 | 17.000 |
| 040 | 0.040 | 255 | 0.550 | 450 | 5.000 | 618 | 18.000 |
| 045 | 0.045 | 260 | 0.600 | 455 | 5.500 | 620 | 20.000 |
| 050 | 0.050 | 265 | 0.650 | 460 | 6.000 | 622 | 22.000 |
| 055 | 0.055 | 270 | 0.700 | 465 | 6.500 | 624 | 24.000 |
| 060 | 0.060 | 275 | 0.750 | 470 | 7.000 | 625 | 25.000 |
| 065 | 0.065 | 280 | 0.800 | 475 | 7.500 | 630 | 30.000 |
| 070 | 0.070 | 285 | 0.850 | 480 | 8.000 | 635 | 35.000 |
| 075 | 0.075 | 290 | 0.900 | 485 | 8.500 | 640 | 40.000 |
| 080 | 0.080 | 295 | 0.950 | 490 | 9.000 | 650 | 50.000 |
| 085 | 0.085 | 410 | 1.000 | 495 | 9.500 | 660 ⁹ | 60.000 |
| 090 | 0.090 | 512 | 1.250 | 610 | 10.000 | 670 ⁹ | 70.000 |
| 095 | 0.095 | 415 | 1.500 | 710 | 10.500 | 680 ⁹ | 80.000 |
| 210 | 0.100 | 517 | 1.750 | 611 | 11.000 | 685 ⁹ | 85.000 |
| 215 | 0.150 | 420 | 2.000 | 711 | 11.500 | 690 ⁹ | 90.000 |
| 220 | 0.200 | 522 | 2.250 | 612 | 12.000 | 695 ⁹ | 95.000 |
| 225 | 0.250 | 425 | 2.500 | 712 | 12.500 | 810 ⁹ | 100.00 |
| 230 | 0.300 | 527 | 2.750 | 613 | 13.000 | | |

OR VOLTAGE COIL (NORMAL RATED VOLTAGE) 7

| CODE | AMPERES | A32 | 32 DC | J12 | 12 AC | J65 | 65 AC |
|------|---------|-----|-------|-----|-------|-----|--------|
| A06 | 6 DC | A32 | 32 DC | J12 | 12 AC | J65 | 65 AC |
| A12 | 12 DC | A48 | 48 DC | J18 | 18 AC | K20 | 120 AC |
| A18 | 18 DC | A65 | 65 DC | J24 | 24 AC | L40 | 240 AC |
| A24 | 24 DC | J06 | 6 AC | J48 | 48 AC | | |

8 TERMINAL

- 1¹⁰ Stud 10-32
- 2¹¹ Screw 1/8-32
- 3¹² Stud 1/4-20
- 4¹¹ Stud M5 x 0.8
- 5¹¹ Screw M5 x 0.8
- 6¹² Stud M6
- 7¹³ 0.250 Double Quick Connect
- 9¹⁵ 7/16" Clip Terminal
- A¹⁴ Plug-In Stud
- C¹⁵ 5/16" Clip Terminal

9 ACTUATOR COLOR & LEGEND 16,17,18

Actuator or

| Visi-Color | Marking: | Marking Color: | Single Color | Rocker/Handle | Visi-Rocker |
|------------|------------|----------------|--------------|---------------|-------------|
| Color: | I-O ON-OFF | Dual/None | Single Color | Rocker/Handle | Visi-Rocker |
| White | A B | 1 | Black | Black | White |
| Black | C D | 2 | White | White | n/a |
| Red | F G | 3 | White | White | Red |
| Green | H J | 4 | White | White | Green |
| Blue | K L | 5 | White | White | Blue |
| Yellow | M N | 6 | Black | Black | Yellow |
| Gray | P Q | 7 | Black | Black | Gray |
| Orange | R S | 8 | Black | Black | Orange |

10 MOUNTING / BARRIERS 1

| | STANDARD ROCKER BEZEL | BARRIERS | VOLTAGE |
|----------------------------|-----------------------|----------|---------|
| 1 | 6-32 x 0.195 inches | no | <300 |
| 2 | 6-32 x 0.195 inches | yes | <300 |
| 3 19 | 6-32 x 0.195 inches | yes | ≥300 |
| 4 | ISO M3 x 5mm | no | <300 |
| 5 | ISO M3 x 5mm | yes | <300 |
| 6 19 | ISO M3 x 5mm | yes | ≥300 |
| RECESSED OFF ROCKER | | | |
| 7 | 6-32 x 0.195 inches | no | <300 |
| 8 | 6-32 x 0.195 inches | yes | <300 |
| 9 | 6-32 x 0.195 inches | yes | ≥300 |
| A | ISO M3 x 5mm | no | <300 |
| C | ISO M3 x 5mm | yes | <300 |
| E | ISO M3 x 5mm | yes | ≥300 |
| PUSH-TO-RESET BEZEL | | | |
| B | 6-32 x 0.195 inches | no | <300 |
| D | 6-32 x 0.195 inches | yes | <300 |
| F 19 | 6-32 x 0.195 inches | yes | ≥300 |
| H | ISO M3 x 5mm | no | <300 |
| J | ISO M3 x 5mm | yes | <300 |
| M 19 | ISO M3 x 5mm | yes | ≥300 |

11 AGENCY APPROVAL

- C UL Recognized & CSA Accepted
- E TUV Certified, UL Recognized & CSA Accepted
- I UL Recognized STD 1077, UL Recognized 1500 (ignition protected), & CSA Accepted
- L UL489 Construction: UL Recognized & CSA Accepted
- R UL489 Construction: TUV Certified, UL Recognized & CSA Accepted

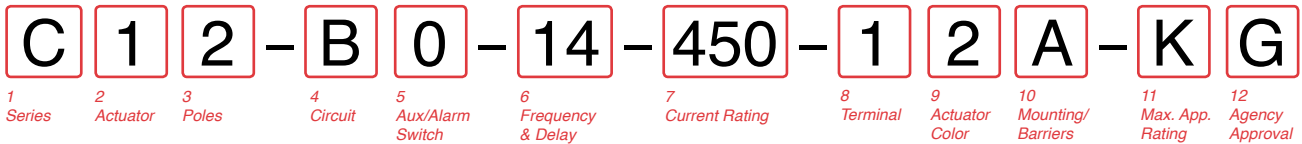

1 SERIES
C

2 ACTUATOR ¹

Two Color Visi-Rocker

- 1 Indicate OFF, vertical legend
- 2 Indicate OFF, horizontal legend
- 3 Vertical legend
- 4 Horizontal legend

Push-To-Reset, Visi-Rocker

- 5 Indicate OFF, vertical legend
- 6 Indicate OFF, horizontal legend
- 7 Vertical legend
- 8 Horizontal legend



3 POLES ²

- 1 One
- 2 Two
- 3 Three

4 CIRCUIT

- B Series Trip (current)

5 AUXILIARY / ALARM SWITCH ³

- 0 without Aux Switch
- 2 S.P.D.T., 0.110 Q.C. Term.
- 3 S.P.D.T., 0.139 Solder Lug
- 4 S.P.D.T., 0.110 Q.C. Term. (Gold Contacts)
- 6 S.P.S.T., 0.139 Solder Lug
- 8 S.P.S.T., 0.187 Q.C. Term.
- 9 S.P.D.T., 0.187 Q.C. Term.

6 FREQUENCY & DELAY

- 11 DC Ultra Short
- 12 DC Short
- 14 DC Medium
- 16 DC Long
- 21 50/60Hz Ultra Short
- 22 50/60Hz Short
- 24 50/60Hz Medium
- 26 50/60Hz Long
- 42 ⁴ 50/60Hz Short, Hi-Inrush
- 44 ⁴ 50/60Hz Medium, Hi-Inrush
- 46 ⁴ 50/60Hz Long, Hi-Inrush
- 52 ⁴ DC Short, Hi-Inrush
- 54 ⁴ DC Medium, Hi-Inrush
- 56 ⁴ DC Long, Hi-Inrush

Notes:

- 1 Push-to-reset actuators have OFF portion of rocker shrouded.
- 2 Multi-pole breakers have all breakers identical except when specifying Auxiliary switch and/or mixed poles, and have one rocker per breaker.
- 3 On multi-pole breakers, one auxiliary switch is supplied, mounted in the extreme right pole.
- 4 Available up to 50 amps maximum.
- 5 Current ratings 71 - 100 with VDE approvals are available up to two poles maximum.
- 6 Terminal Code 1 available to 60 amps maximum.
- 7 Terminal Codes 2, 4, 5 & C available to 50 amps maximum.
- 8 Terminal Codes 3, 6, 9 & A available to 100 amps maximum.
- 9 Terminal Codes 9 & C are not VDE approved.
- 10 Color shown is visi and legend with remainder of rocker black
- 11 Dual = ON-OFF/I-O legend on actuator.
- 12 TUV approval requires Dual (I-O, ON-OFF) markings on rocker.
- 13 Legend on push-to-reset bezel/shroud is white when single color rocker is ordered. Legend on push-to-reset bezel/shroud matches visi-color of rocker with actuator codes 5 & 6.
- 14 Recessed "OFF-SIDE" available with actuator codes 1, 2, 3, & 4. Legends on rocker are available in ink stamping only.
- 15 Barriers supplied on multi-pole units only.
- 16 2 & 3 pole circuit breakers required for 120/240 AC rating.

7 CURRENT RATING (AMPERES) ⁵

| CODE | AMPERES | CODE | AMPERES | CODE | AMPERES | CODE | AMPERES |
|------|---------|------|---------|------|---------|------|---------|
| 210 | 0.100 | 295 | 0.950 | 470 | 7.000 | 618 | 18.000 |
| 215 | 0.150 | 410 | 1.000 | 475 | 7.500 | 620 | 20.000 |
| 220 | 0.200 | 512 | 1.250 | 480 | 8.000 | 622 | 22.000 |
| 225 | 0.250 | 415 | 1.500 | 485 | 8.500 | 624 | 24.000 |
| 230 | 0.300 | 517 | 1.750 | 490 | 9.000 | 625 | 25.000 |
| 235 | 0.350 | 420 | 2.000 | 495 | 9.500 | 630 | 30.000 |
| 240 | 0.400 | 522 | 2.250 | 610 | 10.000 | 635 | 35.000 |
| 245 | 0.450 | 425 | 2.500 | 710 | 10.500 | 640 | 40.000 |
| 250 | 0.500 | 527 | 2.750 | 611 | 11.000 | 650 | 50.000 |
| 255 | 0.550 | 430 | 3.000 | 711 | 11.500 | 660 | 60.000 |
| 260 | 0.600 | 435 | 3.500 | 612 | 12.000 | 670 | 70.000 |
| 265 | 0.650 | 440 | 4.000 | 712 | 12.500 | 680 | 80.000 |
| 270 | 0.700 | 445 | 4.500 | 613 | 13.000 | 685 | 85.000 |
| 275 | 0.750 | 450 | 5.000 | 614 | 14.000 | 690 | 90.000 |
| 280 | 0.800 | 455 | 5.500 | 615 | 15.000 | 695 | 95.000 |
| 285 | 0.850 | 460 | 6.000 | 616 | 16.000 | 810 | 100.00 |
| 290 | 0.900 | 465 | 6.500 | 617 | 17.000 | | |

8 TERMINAL

- 1 ⁶ Stud 10-32
- 2 ⁷ Screw 10-32
- 3 ⁸ Stud 1/4-20
- 4 ⁷ Stud M5 x 0.8
- 5 ⁷ Screw M5 x 0.8
- 6 ⁸ Stud M6
- 9 ^{8,9} 7/16" Clip Terminal
- A ⁸ Plug-In Stud
- C ^{7,9} 5/16" Clip Terminal

9 ACTUATOR COLOR & LEGEND ¹⁰

| Actuator or Visi-Color | Marking: | Marking Color: | Single Color | Visi-Rocker |
|------------------------|----------|-----------------------|---------------|-------------|
| Color: | ON-OFF | Dual ^{11,12} | Rocker/Handle | |
| White | B | 1 | Black | White |
| Black | D | 2 | White | n/a |
| Red | G | 3 | White | Red |
| Green | J | 4 | White | Green |
| Blue | L | 5 | White | Blue |
| Yellow | N | 6 | Black | Yellow |
| Gray | Q | 7 | Black | Gray |
| Orange | S | 8 | Black | Orange |

10 MOUNTING / BARRIERS

| | STANDARD ROCKER BEZEL | BARRIERS ¹⁵ |
|---|-----------------------------------|------------------------|
| | Threaded Insert, 2 per pole | |
| A | 6-32 X 0.195 inches | yes |
| C | ISO M3 x 5mm | yes |
| | RECESSED OFF ROCKER ¹⁴ | |
| | Threaded Insert, 2 per pole | |
| E | 6-32 x 0.195 inches | yes |
| F | ISO M3 x 5mm | yes |
| | PUSH-TO-RESET BEZEL ¹³ | |
| | Threaded Insert, 2 per pole | |
| B | 6-32 x 0.195 inches | yes |
| D | ISO M3 x 5mm | yes |

11 MAXIMUM APPLICATION RATING

- A 65 DC
- B 125 DC
- C 120/240 AC ¹⁶
- D 240 AC
- F 277 AC
- K 120 AC
- M 80 DC

12 AGENCY APPROVAL ¹²

- A without approvals
- G UL 489 Listed & CSA Certified
- J UL489 Listed, CSA Certified & TUV Certified

Circuit & Terminal Diagrams: in. [mm]

| DESCRIPTION | CODE | DIMENSIONAL DETAIL | RATING (AMPS) | | |
|--------------|------|--------------------|---------------|----|-----|
| | | | 25 | 50 | 100 |
| #10-32 STUD | 1 | | | | |
| M5 STUD | 4 | | | | |
| #1/4-20 STUD | 3 | | | | |
| M6 STUD | 6 | | | | |
| #1/4-20 STUD | 3 | | | | |
| M6 STUD | 6 | | | | |
| #10-32 SCREW | 2 | | | | |
| M-5 SCREW | 5 | | | | |

| DESCRIPTION | CODE | DIMENSIONAL DETAIL | RATING (AMPS) | | |
|----------------------|------|--------------------|---------------|----|-----|
| | | | 25 | 50 | 100 |
| .250 DOUBLE Q.C. | 7 | | | | |
| 7/16" CLIP TERMINALS | 9 | | | | |
| PUSH-IN STUD | A | | | | |

NOTES: TOLERANCE ON STUD LENGTHS IS ±.031 [±.79] UNLESS OTHERWISE SPECIFIED.

AUXILIARY / ALARM SWITCH TERMINAL DETAIL³



| TIGHTENING TORQUE SPECIFICATIONS | |
|----------------------------------|---------------------------|
| THREAD SIZE | TORQUE |
| #6-32 [M3] MOUNTING INSERTS | 7-9 IN-LBS [0.8-1.0 NM] |
| #10-32 & M5 THD STUDS | 15-20 IN-LBS [1.7-2.3 NM] |
| #10-32 THD SCREW | 15-20 IN-LBS [1.7-2.3 NM] |
| #1/4-20 & M6 THD STUDS | 30-35 IN-LBS [3.4-4.0 NM] |

| TERMINAL HARDWARE | | | | |
|----------------------|-------|---------------------|---------------|---|
| TERMINAL DESCRIPTION | CODE | AGENCY APPROVAL | AMPERE RATING | HARDWARE SUPPLIED |
| #10-32 STUD | 1 | ALL | .02 - 50 | LOCK WASHER - FLAT WASHER - NUT |
| M5 STUD | 4 | ALL | .02 - 50 | LOCK WASHER - FLAT WASHER - NUT |
| #1/4-20 STUD | 3 | ALL | .02 - 80 | LOCK WASHER - FLAT WASHER - NUT |
| | | | 81 - 100 | LOCK WASHER - NUT - (2) FLAT WASHER - NUT |
| M6 STUD | 6 | ALL | .02 - 80 | LOCK WASHER - FLAT WASHER - NUT |
| | | | 81 - 100 | LOCK WASHER - NUT - (2) FLAT WASHER - NUT |
| #10-32 SCREW | 2 & 5 | UL RECOGNIZED | .02 - 50 | * SADDLE CLAMP - FLAT WASHER - SCREW |
| | | UL-489 LISTED | .02 - 50 | LOCK WASHER - FLAT WASHER - SCREW |
| | | TUV & VDE CERTIFIED | .02 - 16 | * SADDLE CLAMP - FLAT WASHER - SCREW |
| | | TUV & VDE CERTIFIED | 16.1 - 50 | LOCK WASHER - FLAT WASHER - SCREW |

* THE SADDLE CLAMP IS FOR DIRECT WIRE CONNECTION USE. DISCARD SADDLE CLAMP IF WIRE TERMINAL LUG IS USED

Notes:

- All dimensions are in inches [millimeters].
- Tolerance ±.020 [.51] unless otherwise specified.
- Available on Series Trip and Switch Only Circuits when called for on multi-pole units. Only one auxiliary switch is normally supplied, as viewed in multi-pole identification scheme.

Circuit & Terminal Diagrams: in. [mm]

| | CIRCUIT SCHEMATIC | | CIRCUIT CODE | AUX SWITCH CODE | CIRCUIT SCHEMATIC | | CIRCUIT CODE | AUX SWITCH CODE |
|--|-----------------------|-----|--------------|-----------------|-------------------|-----|--------------|-----------------|
| | ANSI | IEC | | | ANSI | IEC | | |
| | SWITCH ONLY (NO COIL) | | | | SERIES TRIP | | | |
| | | | A | O | | | B | O |
| | | | A | 2 3 4 | | | B | 2 3 4 |
| | | | D E | 0 | | | H | 0 |
| | | | F G | 0 | | | K | 0 |

| HANDLE POSITION VS. AUX/ALARM SWITCH MODE | | | | | |
|---|-----------------|------------------|-----------------|----------------------------|--|
| CIRCUIT BREAKER MODE | STANDARD C/B | | MID TRIP C/B | | |
| | HANDLE POSITION | AUX. SWITCH MODE | HANDLE POSITION | STANDARD ALARM SWITCH MODE | REVERSE ALARM SWITCH MODE ⁴ |
| OFF | | | | | |
| ON | | | | | |
| ELECTRICAL TRIP | | | | | |

- Notes:
- All dimensions are in inches [millimeters].
 - Tolerance ±.020 [.51] unless otherwise specified.
 - Schematic shown represents current trip circuits.
 - Available only as special catalog number.

Dimensional Specifications: in. [mm]

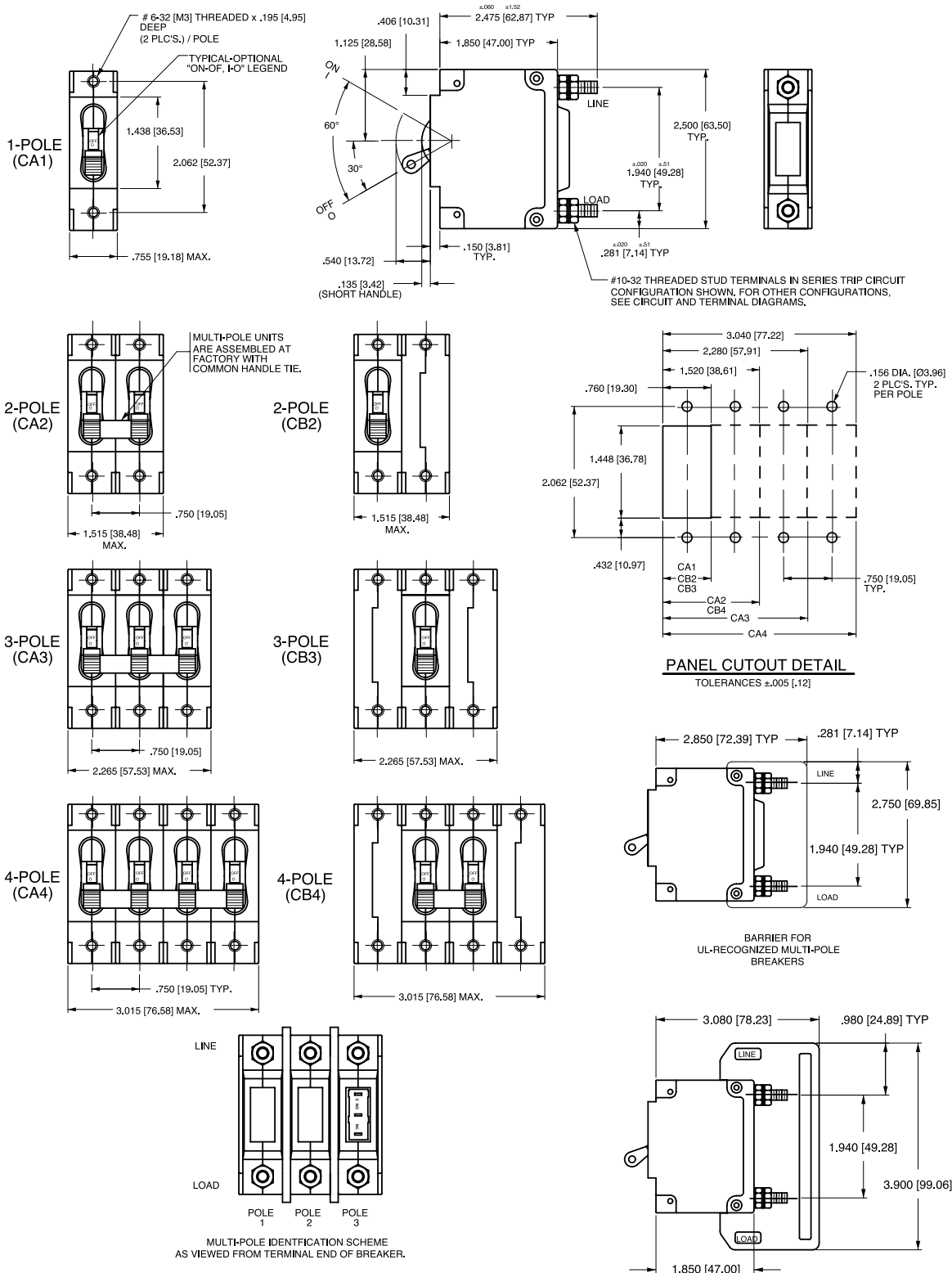

- Notes:
- 1 All dimensions are in inches [millimeters].
 - 2 Tolerance ±.020 [.51] unless otherwise specified.

Dimensional Specifications: in. [mm]



*Handleguard available as special catalog number only

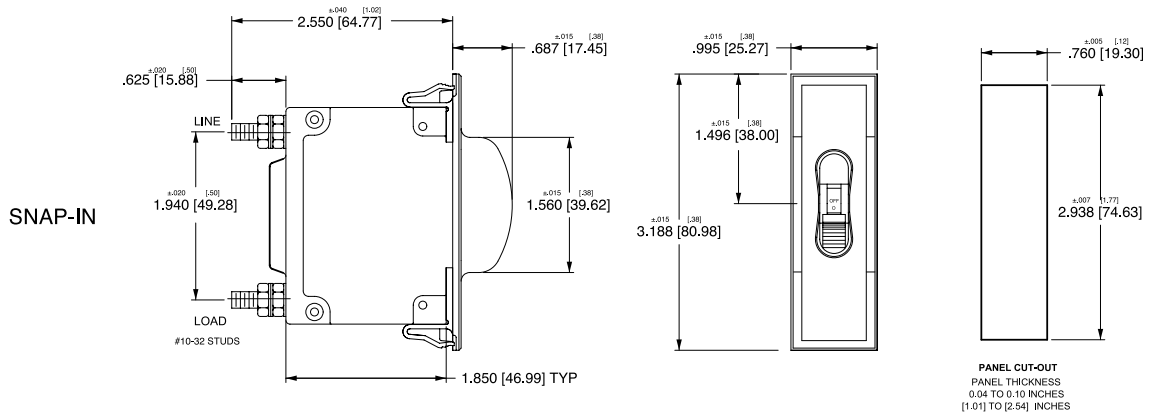

Notes:

- 1 All dimensions are in inches [millimeters].
- 2 Tolerance ± 0.020 [.51] unless otherwise specified.

Dimensional Specifications: in. [mm]

1-POLE (CA1)
w/ ARC CHUTE BARRIER



3-POLE (CA3)
w/ ARC CHUTE BARRIER



INDICATE "ON"

1-POLE (CC1, CD1)
w/ ARC CHUTE (NO BARRIER)

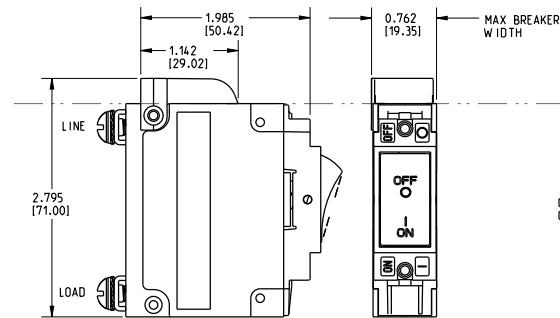

3-POLE (CC3, CD3)
w/ ARC CHUTE BARRIER

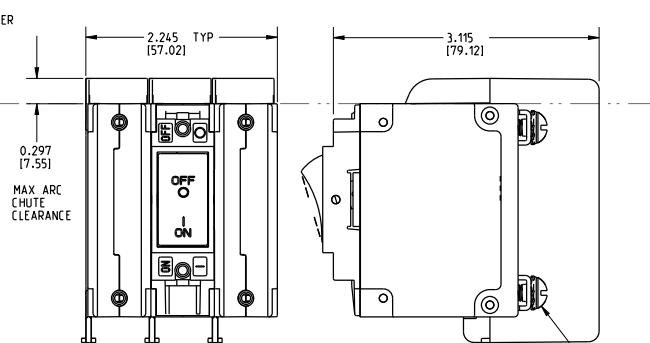

SCREW TYPE TERMINALS IN SERIES TRIP CIRCUIT CONFIGURATION SHOWN.

INDICATE "OFF" / SINGLE COLOR

1-POLE (CF1, CG1, C11, C21)
w/ ARC CHUTE (NO BARRIER)

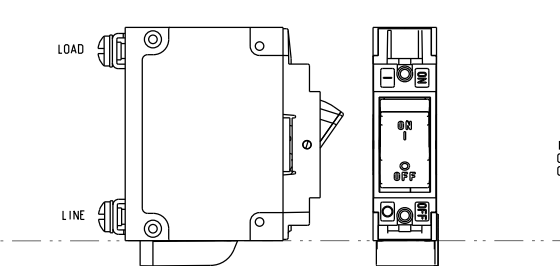

3-POLE (CF3, CG3, C13, C23)
w/ ARC CHUTE BARRIER

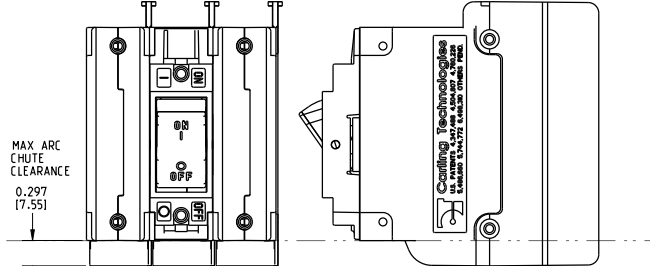

Notes:

- 1 Only 1-pole and 3-pole configurations shown. Arc chute (without barrier) and arc chute barrier also available for 2-pole construction.
- 2 Dimensions apply to all variations shown.
- 3 Notice that line and load terminal orientation for indicate on and indicate off rocker circuit breakers are opposite.
- 4 Screw type terminals shown for Rocker style (CF1, C11, etc) circuit breakers. For other terminal configurations see circuit and terminal diagrams.
- 5 All dimensions are in inches [millimeters].
- 6 Tolerance $\pm .020$ unless otherwise specified.
- 7 Must be ordered under a special catalog number.

Dimensional Specifications: in. [mm]

PARALLEL POLE (CA2-P)

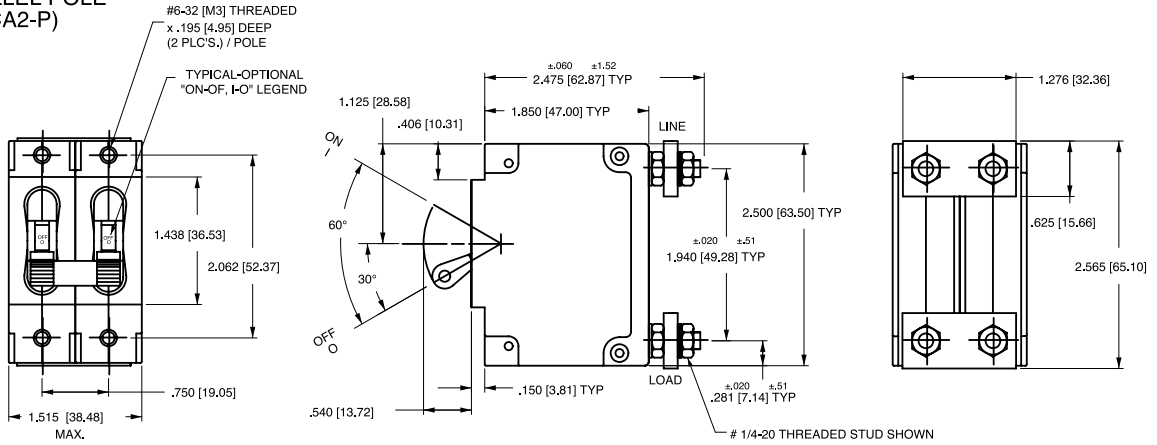

PARALLEL POLE (CA3-P)

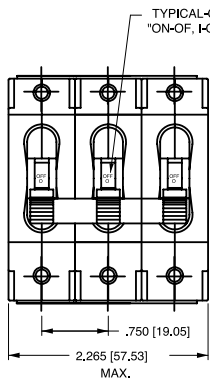

| CIRCUIT BREAKER PROFILE | CIRCUIT SCHEMATIC (CA2-P SHOWN) | | CIRCUIT CODE | AUX SWITCH CODE |
|-------------------------|--|-----|--------------|-----------------|
| | ANSI | IEC | | |
| | SERIES TRIP | | P | 0 |
| | SERIES TRIP WITH AUXILIARY SWITCH | | P | 2 3 4 |

TERMINAL DETAILS



PANEL CUTOUT DETAIL

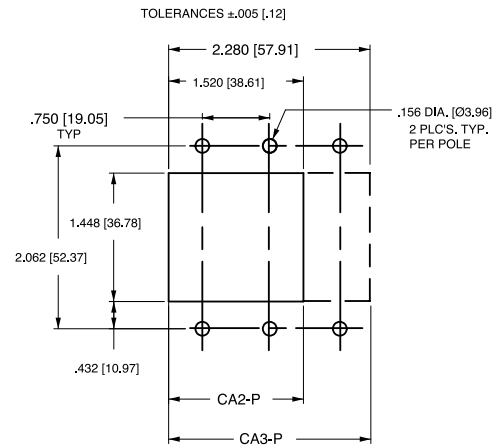

- Notes:
- All dimensions are in inches [millimeters].
 - Tolerance ± 0.020 [.51] unless otherwise specified.

Dimensional Specifications: in. [mm]



SCREW TYPE TERMINALS
IN SERIES TRIP CIRCUIT
CONFIGURATION SHOWN.
FOR OTHER CONFIGURATIONS
SEE CIRCUIT & TERMINAL
DIAGRAMS



PANEL CUTOUT DETAIL
TOLERANCES ±.005[.13]

Notes:

- 1 All dimensions are in inches [millimeters].
- 2 Tolerance ±.020 [.51] unless otherwise specified.

Circuit & Terminal Diagrams: in. [mm]

| CIRCUIT BREAKER PROFILE | CIRCUIT SCHEMATIC | | CIRCUIT CODE | AUX SWITCH CODE | CIRCUIT SCHEMATIC | | CIRCUIT CODE | AUX SWITCH CODE |
|--|--|-----|--------------|-----------------|---|-----|--------------|-----------------|
| | ANSI | IEC | | | ANSI | IEC | | |
| <p>SERIES TRIP (2 TERM'S.)</p> | <p>SWITCH ONLY (NO COIL)</p> | | A | 0 | <p>SWITCH TRIP</p> | | BC | 0 |
| <p>SERIES TRIP W/AUX. SWITCH (5 TERM'S.)</p> | <p>SWITCH ONLY (NO COIL) WITH AUXILIARY SWITCH</p> | | A | 2 3 4 | <p>SERIES TRIP WITH AUXILIARY SWITCH</p> | | BC | 2 3 4 |
| <p>SHUNT TRIP (3 TERM'S.)</p> | <p>SHUNT TRIP</p> | | DE | 0 | <p>DUAL COIL; SERIES TRIP CURRENT COIL, SHUNT TRIP VOLTAGE COIL</p> | | H | 0 |
| <p>SHUNT TRIP (4 TERM'S.)</p> | <p>RELAY TRIP</p> | | FG | 0 | <p>DUAL COIL; SERIES TRIP CURRENT COIL, RELAY TRIP VOLTAGE COIL</p> | | K | 0 |



BARRIER FOR
UL-RECOGNIZED MULTI-POLE
BREAKERS



BARRIER FOR
UL-489 LISTED MULTI-POLE
BREAKERS

Notes:

- 1 All dimensions are in inches [millimeters].
- 2 Tolerance ± 0.020 [.51] unless otherwise specified.
- 3 Schematic shown represents current trip circuit.

Dimensional Specifications: in. [mm]



Notes:

- 1 Dimensions apply to all variations shown. Notice that circuit breaker line and load terminal orientation on indicate OFF is opposite of indicate ON.
- 2 For pole orientation with horizontal legend, rotate front view clockwise 90°.
- 3 All dimensions are in inches [millimeters].
- 4 Tolerance ± 0.020 [5.1] unless otherwise specified.

Dimensional Specifications: in. [mm]

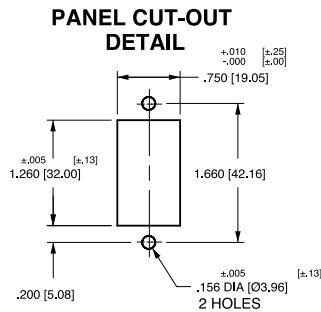

PUSH-TO-RESET ACTUATOR

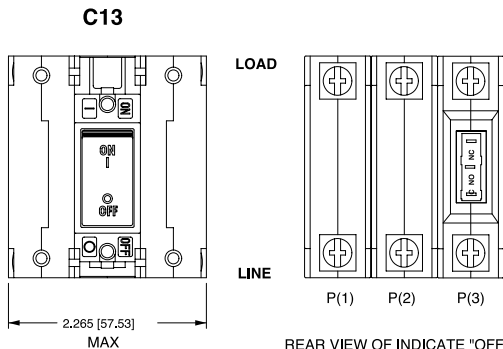

REAR VIEW OF INDICATE "OFF" SERIES TRIP W/ AUX SWITCH CIRCUIT CONFIGURATION.

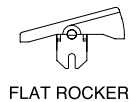
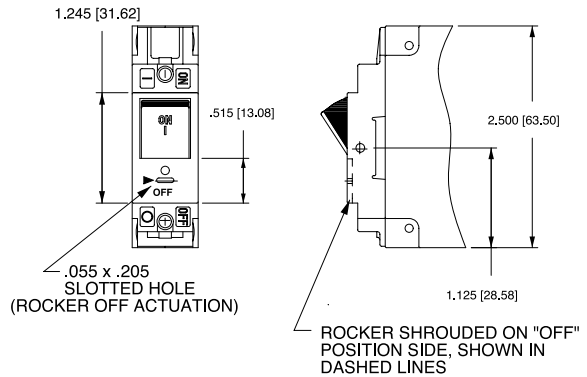

- Notes:
- 1 For pole orientation with horizontal legend, rotate front view clockwise 90°.
 - 2 All dimensions are in inches [millimeters].
 - 3 Tolerance ±.020 [.51] unless otherwise specified.

Authorized Sales Representatives and Distributors

Click on a region of the map below to find your local representatives and distributors or visit www.carlingtech.com/findarep.



About Carling

Founded in 1920, Carling Technologies is a leading manufacturer of electrical and electronic switches and assemblies, circuit breakers, electronic controls, power distribution units, and multiplexed power distribution systems. With four ISO registered manufacturing facilities and technical sales offices worldwide, Carling Technologies Sales, Service and Engineering teams do much more than manufacture electrical components, they engineer powerful solutions! To learn more about Carling please visit www.carlingtech.com/company-profile.

To view all of Carling's environmental, quality, health & safety certifications please visit www.carlingtech.com/environmental-certifications

Worldwide Headquarters

Carling Technologies, Inc.
60 Johnson Avenue, Plainville, CT 06062
Phone: 860.793.9281 **Fax:** 860.793.9231
Email: sales@carlingtech.com

Northern Region Sales Office: nrsm@carlingtech.com
Southeast Region Sales Office: sersm@carlingtech.com
Midwest Region Sales Office: mrsrm@carlingtech.com
West Region Sales Office: wrsm@carlingtech.com
Latin America Sales Office: larsm@carlingtech.com

Asia-Pacific Headquarters

Carling Technologies, Asia-Pacific Ltd.,
Suite 1607, 16/F Tower 2, The Gateway,
Harbour City, 25 Canton Road,
Tsimshatsui, Kowloon, Hong Kong
Phone: Int + 852-2737-2277 **Fax:** Int + 852-2736-9332
Email: sales@carlingtech.com.hk

Shenzhen, China: shenzhen@carlingtech.com
Shanghai, China: shanghai@carlingtech.com
Pune, India: india@carlingtech.com
Kaohsiung, Taiwan: taiwan@carlingtech.com
Yokohama, Japan: japan@carlingtech.com

Europe | Middle East | Africa Headquarters

Carling Technologies LTD
4 Airport Business Park, Exeter Airport,
Clyst Honiton, Exeter, Devon, EX5 2UL, UK
Phone: Int + 44 1392.364422 **Fax:** Int + 44 1392.364477
Email: ltd.sales@carlingtech.com

Germany: gmbh@carlingtech.com
France: sas@carlingtech.com



Carling Technologies®

Innovative Designs. Powerful Solutions.